

# Digital Key Telephone User Guide.

**MODEL: KD, KD/E, LKD Series.**

**130/300 codes also relate to the 7000 series handsets.**

For LG Aria Systems: 16/20, 34e, 100, 186, 130, 300

(Most of the information is also relevant to the following models:  
20W, 24ipe, 162, 100SB, 130c and 600.)

**Quick Reference Guide for Digital Key Telephone**

Quick Ref. Guide

**Fixed Feature Buttons**

- **FLASH** button is used to terminate an outside call and re-seize dial tone without having to hang up the handset.
- **SPEED** button provides you with access to speed dialing, save number redial and last number redial.
- **TRANS** (TRANSFER) button is used to transfer an outside call from a station to another.
- **CALLBK** (CALLBACK) button allows you to leave a callback indication at a station that is busy, unattended, or in Do Not Disturb.
- **CONF** button is used to establish conference calls.
- **DND/FWD** (Do Not Disturb/Forward) button allows you to forward your calls to another destination, or make DND mode.
- **MUTE** button allows you to switch the built in microphone on or off when using the speakerphone or the handset microphone when using the handset.
- **MON** button enables you to make a phone call with -out lifting handset. It turns the telephone on and off when using the speakerphone.
- **HOLD** button enables you to place an outside caller on hold.
- **REDIAL** allows you to make last number redial and auto call number redial.
- **VOLUME** ▲ bar allows you to adjust speakerphone and handset volume.

**Call Forward**

- Press MON button.
- Press DND/FWD button and dial the desired Call Forward type.
  - 0 : Follow me (not available in Aria-16/20W)
  - 1 : Unconditional
  - 2 : Busy calls
  - 3 : No answer calls
  - 4 : Busy/no answer calls
  - 5 : Station off-net
  - 6 : Incoming outside line to off-net (ATD only)
  - 7 : DVU forward for no answer-1 (after 4sec)
  - 8 : DVU forward for no answer-2 (after predefined time)
  - 9 : DVU forward for busy
  - # : Cancel previous call forward
- Dial the station number or press DSS button or intercom group where calls are forwarded. (Confirmation tone is heard.)
- In Aria-16/20W, only 1 DVIB forward is available. (DND/FOR + '7': DVU forward for no answer/busy)
- In Aria-300/130, Forward type 0~7 are available.
  - (5 : Station off-net, unconditional
  - 6 : Station off-net, no answer
  - 7 : Incoming outside line to off-net (Sys. ATD only))
 To make Call forward to VMIB, press # key after dialing call forward type (1~4).

**Call Wait (Camp-on)**

- If you dial a busy station, you may alert it to your call.
- After receiving intercom busy tone, dial \* or the last digit of called station number or press DSS button.
  - When the called party answers, consult with them or hang up to transfer the call, if any.

**Conference**

- Call the desired party (internal or outside). When called party answers, press CONF button.
- Add next conference party by selecting another outside line or intercom station.
- When the party answers, press CONF button twice. All parties are connected.

To terminate a conference.

The conference initiator should be actively in the conference.

- Hang up, or press CONF button to finish the conference (only for conference initiator).

**Leaving a Message Waiting Indication**

If you dial a station that is unattended or in Do Not Disturb, you can leave a message waiting indication.

- Dial the desired intercom station. Busy tone or DND tone is heard.
- Press CALLBK button. The called party's CALLBK button LED will flash.

To answer a Message Waiting Indication.

- Press flashing CALLBK button and the station that left message will be signaled with tone ringing.
- If called station does not answer, press the CALLBK button once to leave a message.

**Placing an Outside Call on Hold**

While connected to an outside line,

- Press HOLD/SAVE button.
  - Once for system hold
  - Twice for exclusive hold
- Reverse if hold preference is programmed to system hold.
- Press HOLD/SAVE button. (in Aria-16/20W) CO line call will be put on hold according to the Hold Preference.

**Last Number Redial**

The last dialed number on an outside line is saved.

- Press REDIAL button. Or,
- Press SPEED button and dial \*.
- In Aria-300/130, each station with LCD has 10 last dialed number directory. You may find a dialed number by pressing VOLUME key. And press HOLD/SAVE button to dial the number.

**Note: The feature which is marked ( \* ), is not available in Aria-16/20/20W.**

**Quick Reference Guide for Digital Key Telephone**

Quick Ref. Guide

**Save Number Redial ( \* )**

If you wish to save a number you dialed,

- After dialing the number of an outside party, keep the handset off-hook.
- Press SPEED button twice.

To dial a saved number,

- Press SPEED button and dial #.

**Call Transfer**

While connected to an outside call,

- Press TRANS/PGM button.
- Dial station number or DSS button.  
(You can select a screened or unscreened transfer.)

Screened Transfer

When that extension answers, announce the transfer and hang up to complete call transfer.

Unscreened Transfer

When the called extension begins to signal, hang up to complete call transfer.

**Storing Speed Dial Numbers**

- Press TRANS/PGM button and then SPEED button.
- Dial the speed number bin.
  - Station Speed Number bin : 00~19  
000~099 (Aria-300/130)
  - \* 01~20 :Aria-16(ver. 1.0~3.0),Aria-20W(ver: 1.0~2.0)
  - \* 01~19 :Aria-16(ver. 4.0),Aria-20W(ver: 3.0)
  - System Speed Number bin : 200~999 (Aria-186)  
(Attendant programmed) 200~399 (Aria-34e/100)  
21~99 (Aria-16/20W)  
2000~4999 (Aria-300)  
2000~3499 (Aria-130)
- Dial the phone numbers to be stored.
- Press HOLD/SAVE button to save the number.

To erase an exiting speed bin.

- Press TRANS/PGM button and then SPEED button.
- Dial speed number bin to be erased.
- Press HOLD/SAVE button.

**Dialing a Speed Number**

- Press SPEED button and dial the speed number bin.
- When the called party answers, pick up the handset or use speakerphone.

**Voice Over ( \* )**

It is available when the station has been programmed with voice over.

- When a busy keyset engaged in an internal or external call is called through camp-on by a caller, HOLD/SAVE button of busy keyset is flashing.
- After tone, the busy keyset will be connected to both parties.

**Queuing ( \* )**

You see that a particular line is busy and want to be placed on a list waiting for the first line in the group or station to become available.

- Lift handset or press MON button.
- Press the busy outside line button, specific line group button or DSS button.
- Pressing CALLBK button, your CALLBK button is lighting and confirmation tone is heard.
- Hang up or press MON button.

To answer a queue request.

- When the busy outside line button, specific line group button or DSS button returns to idle, you hear ringing and the queued line button flashes.
- Lift handset and dial outside line.

**Attendant Clock Set**

The attendant can set the Time/Date without entering Admin. Programming.

- Press TRANS/PGM button.
- Dial # 1.
- Enter Date/Time. (YYMMDDHHmm)  
If there is no need to change date or time, press \* key.
- Press HOLD/SAVE button.
- In Aria-16/20W & Aria-300/130.
- Press TRANS/PGM button.
- Dial # 1 (0 4 1 in Aria-300/130).
- Enter Date (YYMMDDHH) and press HOLD/SAVE button.
- Enter Time (HHmm) and press HOLD/SAVE button.  
If there is no need to change date or time, do not dial current date/time and press HOLD/SAVE button.

**Flexible Buttons Programming**

- Press TRANS/PGM button.
- Press a flexible button to be programmed.
- See the below chart and dial the desired code.
- Press HOLD/SAVE button.

Direct Station Select	100~399 (Aria-300) 100~227 (Aria-130) 100~291 (Aria-186) 100~235 (Aria-100) 100~177 (Aria-34e) 100~115 (Aria-16/20W)
Call Park ( * )	601~619 (Aria-186/Aria-300) 601~610 (Aria-100/Aria-130) 601~605 (Aria-34e)
Call Wait (Camp-on)	TRANS/PGM + 8 5
Station Speed Dial	SPEED + bin no. (00~19) 000~099 (Aria-300/130)
* 01~20 :Aria-16(ver. 1.0~3.0),Aria-20W(ver: 1.0~2.0)	
System Speed Dial	SPEED + bin no. 2000~4999 (Aria-300) 2000~3499 (Aria-130) 200~999 (Aria-186) 200~399 (Aria-100/34e) 21~99 (Aria-16/20W)
All Call Page	#00 (# 0 in Aria-16/20W #00 in Aria-300/130)
Universal Night Answer	77 (577 in Aria-300/130) (69 in 20/20W)
Last Number Redial	SPEED + *
Save Number Redial( * )	SPEED + #

To erase a flexible button,

- Press TRANS/PGM button.
- Press the flexible button to be erased.
- Press HOLD/SAVE button.

**CONTENTS**

**Digital Key Telephone Family**..... 7  
**Button Arrangement for Digital Key Telephone Family** ..... 9

**CO Line Features**

Placing an Outside Call .....11  
 Answering an Outside Call..... 11  
 Call Transfer .....11  
 Last Number Redial.....12  
 Save Number Redial.....12  
 Dial Memo.....13  
 Auto Call Number Redial.....13  
 Queuing.....13  
 Executive/Secretary Transfer .....14  
 Step Call .....14  
 Speed Dial Numbers .....14  
 Storing Dial By Name .....15  
 Call Park .....16  
 Universal Night Answer.....16

**Intercom Features**

Changing Intercom Answer Mode ..... 17  
 Placing an Intercom Call .....18  
 Answering an Intercom Call .....18  
 Placing an Intercom on Hold.....18  
 Changing Differential Ring .....19  
 Voice Over.....20  
 Answering a Call Wait with Voice Over .....20  
 Directed Call Pick-up.....20  
 Call Wait (Camp-on) .....21  
 Mute .....21  
 Call Back.....21  
 Message Waiting.....22  
 Do Not Disturb.....22  
 Call Forward .....23  
 Paging .....25  
 Flash .....26  
 Speakerphone .....27  
 Speaker Volume Control.....27  
 Ring Volume Control .....27

**System Features**

Placing an Intercom Group Call.....28  
 Placing a CO Call on Hold .....28  
 Group Call Pick-up.....28  
 Conference .....29  
 Access Authorization Code.....30  
 Blocking Outside Calls .....32  
 Restoring Outside Calls .....32  
 Wake-up Call .....33  
 Using Dial By Name .....34  
 Programming Your Name into Display .....37  
 Pre-selected Message .....37  
 User Custom Message Programming .....39  
 Background Music.....40  
 Voice Announcement .....40  
 CO Message Wait .....47  
 DISA (Direct Inward System Access) .....47  
 LCD Language Change .....47  
 Alarm Reset .....48  
 Two-way Recording .....49

CO Line Features

Intercom Features

System Features

**CONTENTS**

**Large LCD Keypad Features**

LCD Brightness Control ..... 49  
 Calendar Display..... 49  
 Door Open ..... 50

Station Programming Menu Table (Aria-300/130) ..... 51  
 Flexible Button Programming ..... 52

**Attendant Operation**

Wake-up Call..... 54  
 System Greetings..... 56  
 Attendant Clock Set ..... 57  
 Changing Time/Date Format ..... 58  
 To Set Current Time 1 Hour Early/Late ..... 59  
 System Speed Dial..... 60  
 Attendant Intrusion ..... 60  
 Day/On-demand/Night Mode Service (Manual/Automatic) ..... 61  
 Day/On-demand/Night/Weekend Mode Service (Aria-300/130)..... 61  
 Day/Night/Auto Ring Mode Service (Aria-16/20W)..... 62  
 To Print out Accumulated SMDR Records..... 62  
 To Erase SMDR Record..... 64  
 Dial By Name (for ICM)..... 65  
 Customized Message..... 66  
 CO Outgoing Disable..... 67  
 Temporary COS Change..... 67  
 Traffic Analysis..... 68  
 Erasing Station Message ..... 69  
 Attendant LCD Language ..... 70  
 Intercom Box BGM Selection by Attendant ..... 71  
 External Page Port BGM Selection by Attendant ..... 72  
 Attendant DSS Operation ..... 73  
 Make a Page ..... 73  
 Transferring an Outside Line to Another Station..... 73  
 Intercom Group Call ..... 73  
 Overriding a Key Telephone in Do Not Disturb ..... 73  
 Attendant Programming Menu Table (Aria-300/130)..... 74

**Hotel Operation(Aria)**

**This part of the user Guide has not been added. It is available on the dealer website.**

Introduction..... 76  
 Register Hotel Name..... 76  
 Check-In..... 76  
 Check-In /Change a Guest's Room Status..... 77  
 Register & Change a Guest Name (Room Status Type 1)..... 77  
 Class of Service (Room Status Type 2)..... 78  
 Guest Alarm Call (Room Status Type 3)..... 78  
 Intercom Enable/Disable (Room Status Type 4)..... 78  
 Room to Room Call Group (Room Status Type 5)..... 79  
 Authorization Code (Room Status Type 6)..... 79  
 Pre-paid Call Charge (Room Status Type 7)..... 79  
 Call Charge Rate (Room Status Type 8)..... 80  
 Baby Listening ..... 80  
 Check-Out ..... 80  
 Room Charge Display & Printing ..... 81  
 Printing a Guest's Room Status ..... 81  
 Intercom Call Enable/Disable ..... 81  
 One-Time CO Call Enable ..... 82  
 Change LCD Display Language ..... 82  
 Bath Alarm ..... 83  
 Maid Status ..... 83  
 Register Bar & Mini-Bar Charge ..... 84

Large LCD

Attendant Operation

Hotel Operation

**CONTENTS**

Room to Room Call Group..... 84

Room Rate Assign..... 84

Fee for Part Time..... 85

Auto Internal Speed Directory ..... 85

Multiple Front Desk ..... 86

New Cabina Call ..... 86

Brief SMDR Print ..... 86

**Hotel Operation(Aria)**

**This part of the user Guide has not been added. It is available on the dealer website.**

Introduction..... 87

Register Hotel Name..... 87

Check-In..... 87

Check-In /Change a Guest's Room Status..... 88

Register & Change a Guest Name (Room Status Type 1)..... 88

Class of Service (Room Status Type 2)..... 89

Guest Alarm Call (Room Status Type 3)..... 89

Intercom Enable/Disable (Room Status Type 4)..... 89

Room to Room Call Group (Room Status Type 5)..... 90

Authorization Code (Room Status Type 6)..... 90

Pre-paid Call Charge (Room Status Type 7)..... 90

Call Charge Rate (Room Status Type 8)..... 91

Baby Listening ..... 91

Check-Out ..... 91

Room Charge Display & Printing ..... 92

Printing a Guest's Room Status ..... 92

Intercom Call Enable/Disable ..... 92

One-Time CO Call Enable ..... 93

Change LCD Display Language ..... 93

Bath Alarm ..... 94

Maid Status ..... 94

Register Bar & Mini-Bar Charge ..... 95

Room to Room Call Group..... 95

Room Rate Assign..... 95

Fee for Part Time..... 96

Auto Internal Speed Directory ..... 96

Multiple Front Desk ..... 97

New Cabina Call ..... 97

Brief SMDR Print ..... 97

**Index (Alphabetical Order) ..... 76**

**CONTENTS**

Blank Page

## Digital Key Telephone Family

Large Digital Key Telephone (You cannot use Large LCD keyset with Aria-16/20/20W system.)

- KD-33LD
- KD/E-36LD

# Pictures Not Available

### KD Series

- KD-36D
- KD-24N

KD-36D : LCD Display, 24 Flexible Buttons  
KD-36N : No LCD Display, 24 Flexible Buttons  
KD-24D : LCD Display, 12 Flexible Buttons  
KD-24N : No LCD Display, 24 Flexible Buttons

### KD/E Series

- KD/E-36EXE
- KD/E-24ENH
- KD/E-8BTN

KD/E-36EXE : LCD Display, 24 Flexible Buttons  
KD/E-36ENH : No LCD Display, 24 Flexible Buttons  
KD/E-24EXE : LCD Display, 12 Flexible Buttons  
KD/E-24ENH : No LCD Display, 24 Flexible Buttons  
KD/E-8 BTN : No LCD Display, 8 Flexible Buttons



## Digital Key Telephone Family

**LKD Series** (You cannot use LKD-30LD with Aria-16/20/20W system.)

• LKD-2N/S

• LKD-8D/S

• LKD-30LD

# Pictures Not Available

LKD-2N/S: No LCD Display, 2 Flexible Buttons

LKD-8D/S: LCD Display, 8 Flexible Buttons

LKD-30D: LCD Display, 30 Flexible Buttons (Dual LED with Flex. BTN 01~24 & Single LED with 25~30)

LKD-30LD: Large LCD Display, 30 Flexible Buttons (Dual LED with Flex. BTN 01~24 & Single LED with 25~30)

LKD-DSS: 48 Flexible Buttons

※ The LKD series keysets can be normally operated in the following S/W version or later.

Aria-34e: GS40P-1.2A // Aria-100: GS00P-3.2A // Aria-186: GS86P-5.1A

Aria-34e: GS40P-1.1Cd // Aria-100: GS00P-3.1Df // Aria-186: GS86P-4.0Ee

**KE/C, KD/C Series** (CTI is not available with Aria-16/20/20W/34e/100/186 system.)

KE/C, KD/C Series keysets have normal functions as KD, KD/E keysets and CTI (Computer Telephony Integration) function to connect PC (RS-232C Interface Function). Connecting CTI Module, the KE/C, KD/C keyset operates to transmit/receive data to communicate with PC.

### Installation Guide for Connection CTI Module to KE/C, KD/C keyset

1. Connect KE/C, KD/C keyset to KTU port of CTI module with 6-pin line cord.
2. Connect KSU to KSU port of CTI module with 4-pin line cord.
3. Connect the serial port of PC to the serial port of CTI module with 9-pin RS-232C cable.

## Button Arrangement for Digital Key Telephone Family

Large Digital Key Telephone (You cannot use large LCD keyset with Aria-16/20/20W system.)

• KD-33LD

• KD/E-36LD

# Pictures Not Available

### KD Series

• KD-36D

• KD-36N

• KD-24D

• KD-24N

## Button Arrangement for Digital Key Telephone Family

### KD/E Series

- KD/E-36EXE
- KD/E-24ENH
- KD/E-8BTN

# Pictures Not Available

### LKD Series

- LKD-8D/S
- LKD-30D

## Placing an Outside Call

Button	Procedures	Range
 MON	<ul style="list-style-type: none"> <li>Lift handset or press <b>MON</b> button.</li> <li>Press outside line button, pool button or dial <u>CO line access code</u>.</li> <li>Dial desired party.</li> <li>When called party answers, lift handset or use speakerphone.</li> </ul>	9 (or 0), 8 + Aria-300:01~72 Aria-130:01~24 186 : 01 ~ 48 100 : 01 ~ 24 34e : 01 ~ 09 16/20W: 1 ~ 4 Or, 88 + Aria-300:001~200 Aria-130:01~40 186 : 01 ~ 96 100 : 01 ~ 48 34e : 01 ~ 34 16 : 1 ~ 6 20W : 1 ~ 8

## Answering an Outside Call

Button	Procedures	Range
 MON	<ul style="list-style-type: none"> <li>Lift handset or press <b>MON</b> button to use speakerphone.</li> <li>Press flashing CO line button or loop key. (If the <i>Preferred Line Answer</i> feature is ON for your station, you may answer just by lifting handset.)</li> </ul>	

## Call Transfer

Button	Procedures	Range
 TRANS/PGM	<p><i>To transfer an outside call to the other extension,</i></p> <ul style="list-style-type: none"> <li>Press <b>TRANS/PGM</b> button. (The outside call is put on hold.)</li> <li>Dial <u>station number</u> or appropriate DSS button.</li> <li>You can make a screened or unscreened transfer.</li> </ul>	Aria-300:100~399 Aria-130:100~227 186 : 100 ~ 291 100 : 100 ~ 235 34e: 100 ~ 177 16 : 100 ~ 115 20: 100 ~ 121 20W: 100 ~ 133
<i>Screened Transfer</i>	<p>When the called extension answers, notice the call transfer and hang up to complete call transfer.</p>	
<i>Unscreened Transfer</i>	<p>While the station you called rings, hang up to complete call transfer.</p> <p><i>To answer screened transfer,</i></p> <ul style="list-style-type: none"> <li>When a station rings according to Intercom Answer Mode selection, answer the intercom call.</li> <li>The transferring party hangs up, the call will be connected.</li> </ul>	

**Note :** The feature which is marked ( \* ), is not available in Aria-16/20/Aria-20W.

## Last Number Redial

Button	Procedures	Range
	<p>The last dialed number on an outside line is saved. To redial the last dialed number,</p> <ul style="list-style-type: none"> <li>• Press <b>REDIAL</b> button. Or,</li> <li>• Press <b>SPEED + *</b>.</li> </ul>	
<i>In Aria-300/130</i>		
	<p>Each station with LCD has 10 individual last dialed number directory. To use one of dialed numbers in the directory by scrolling,</p> <ul style="list-style-type: none"> <li>• Press <b>REDIAL</b> button. Or,</li> <li>• Press <b>SPEED + *</b>.</li> <li>• When the last dialed number is displayed. Press <b>VOLUME</b> (▲/▼) button to find a phone number.</li> <li>• Press <b>HOLD/SAVE</b> button then, the number is dialed.</li> </ul>	

## Save Number Redial ( \* )

Button	Procedures	Range
	<p>If you want to save a number you dialed,</p> <ul style="list-style-type: none"> <li>• After dialing the number of an outside party, keep handset off-hook state.</li> <li>• Press <b>SPEED</b> button twice.</li> <li>• Hang up.</li> </ul> <p><i>To dial a saved number,</i></p> <ul style="list-style-type: none"> <li>• Press <b>SPEED + #</b>.</li> </ul>	

## Dial Memo ( \* )



While on an outside line or intercom call, you may enter and save a number in the save number redial bin for future use. *(This feature is not available in Aria-300/130 system.)*

CO Line Features

Button	Procedures	Range
	<ul style="list-style-type: none"> <li>Press the programmed <b>DIAL MEMO</b> button. To program [DIAL MEMO] button, [TRANS/PGM] + flexible button + [TRANS/PGM] + 8 0 + [HOLD/SAVE]</li> <li>Dial the desired number.</li> <li>Press <b>DIAL MEMO</b> button again to save.</li> </ul> <p><i>To dial the dial memo number,</i></p> <ul style="list-style-type: none"> <li>Press <b>SPEED</b> + #.</li> </ul> <p><i>To check the dial memo number,</i></p> <ul style="list-style-type: none"> <li>In idle state, press <b>DIAL MEMO</b> button.</li> <li>The saved number is displayed on the LCD.</li> </ul>	



## Auto Call Number Redial

When the called party is busy or does not answer the call, the system can automatically redial the number by pre-programmed time interval.

Button	Procedures	Range
 	<ul style="list-style-type: none"> <li>Press <b>REDIAL</b> button.</li> <li>Hang up.</li> <li>A busy or no answer number will be redialed automatically after pre-programmed time interval while <b>MUTE</b> button is lighting.</li> <li>When called party answers, lift handset to talk.</li> </ul>	16: Above V4.0 20W: Above V3.0

## Queuing

When a CO line is busy, you can request a call back when the CO line is available. As soon as it becomes idle, you can be the first extension to get the CO line.

Button	Procedures	Range
 	<ul style="list-style-type: none"> <li>Lift handset or press <b>MON</b> button.</li> <li>Press busy outside line button or specific line group button.</li> <li>Pressing <b>CALLBK</b> button, your <b>CALLBK</b> button is lighting and confirmation tone is heard.</li> <li>Hang up or press <b>MON</b> button.</li> </ul> <p>To answer a queue request,</p> <ul style="list-style-type: none"> <li>When the busy CO line or specific line group returns to idle, you hear ring and the queued line button is flashing.</li> <li>Lift handset and dial a desired phone number.</li> </ul>	16: Above V4.0 20W: Above V3.0

### Executive/Secretary Transfer ( \* )

Button	Procedures	Range
	<ul style="list-style-type: none"> <li>• When the Executive Station is busy or DND (Do Not Disturb), all calls will go to the Secretary Station.</li> <li>• The Secretary Station may signal the Executive Station that is in DND by using Call Wait feature. (Press * key or dial the last digit of the number of Executive station or press the DSS button to operate Call Wait feature.)</li> </ul>	



### Step Call ( \* )

When an extension is busy, you can make a call to a different station by dialing only the last digit of new station number.





Button	Procedures	Range
	<ul style="list-style-type: none"> <li>• Dialing an extension number, and the station is busy.</li> <li>• After hearing ICM busy tone, dial the last digit of the next extension number in the same 10's group. (ex. If station "112" is busy, dial digit "4" to call station "114".)</li> <li>• It can be used for CO line call by pressing <b>SPEED</b> button + last digit.</li> </ul>	

### Speed Dial Numbers (Station Basis)

Each extension can program up to 20 individual speed dial numbers in the station. The numbers are entered and stored by the user and it can be recalled at any time.

Button	Procedures	Range
  	<p><i>To store station speed numbers,</i></p> <ul style="list-style-type: none"> <li>• Press <b>TRANS/PGM</b> button.</li> <li>• Press <b>SPEED</b> button.</li> <li>• Dial <u>speed number bin</u>.</li> <li>• Dial the phone numbers to be stored.</li> <li>• Press <b>HOLD/SAVE</b> button.</li> <li>• Enter name for Dial by Name. (optional)</li> </ul> <p style="text-align: center;"><i>Or,</i></p> <ul style="list-style-type: none"> <li>• Press <b>TRANS/PGM</b> button.</li> <li>• Press <b>SPEED</b> button.</li> <li>• Dial speed number bin.</li> <li>• Press desired outside line or specific line group button.</li> <li>• Dial the phone number to be stored.</li> <li>• Press <b>HOLD/SAVE</b> button.</li> <li>• Enter name for Dial by Name. (optional)</li> <li>• Press <b>HOLD/SAVE</b> button.</li> </ul>	<p>Station Speed bin                      Aria-300 : 000~099                      Aria-130 : 000~099                      186/100/34e: 00~19                      /16/20W</p> <p>Dial by Name :                      16: Above V4.0                      20W: Above V3.0</p> <p><i>Aria-16/20W:</i>                      Line group button is not available.</p>



## Speed Dial Numbers (Station Basis) (Cont'd)

Button	Procedures	Range
 MON  SPEED	<p><i>To use station speed numbers,</i></p> <ul style="list-style-type: none"> <li>• Lift handset or press <b>MON</b> button.</li> <li>• Press <b>SPEED</b> button.</li> <li>• Dial speed number bin.</li> </ul> <p><i>To use system speed numbers,</i></p> <ul style="list-style-type: none"> <li>• Lift handset or press <b>MON</b> button.</li> <li>• Press <b>SPEED</b> button.</li> <li>• Dial <u>speed number bin</u>.</li> </ul>	System Speed bin Aria-300: 2000~4999 Aria-130: 2000~3499 186 : 200~999 100 : 200~399 34e : 200~399 16/20W : 21~99
 TRANS/PGM  SPEED  HOLD/SAVE	<p><i>To erase station speed numbers,</i></p> <ul style="list-style-type: none"> <li>• Press <b>TRANS/PGM</b> button.</li> <li>• Press <b>SPEED</b> button.</li> <li>• Dial speed number bin to be erased.</li> <li>• Press <b>HOLD/SAVE</b> button.</li> </ul>	

CO Line Features

## Storing Dial by Name



Users for digital display phone can enter the called party's name so they can dial by name instead of dialing the phone number.

Button	Procedures												
 TRANS/PGM  SPEED	<ul style="list-style-type: none"> <li>• Press <b>TRANS/PGM</b> button.</li> <li>• Press <b>SPEED</b> button and speed number bin.</li> <li>• Dial the desired phone number.</li> <li>• Press <b>HOLD/SAVE</b> button.</li> <li>• Enter the name up to 16 letters using the code below;</li> </ul>	16 : Above V4.0 20W : Above V3.0											
 HOLD/SAVE	<table border="1" data-bbox="493 1429 794 1868"> <tbody> <tr> <td>Q - 11 Z - 12 . - 13 1 - 10</td> <td>A - 21 B - 22 C - 23 2 - 20</td> <td>D - 31 E - 32 F - 33 3 - 30</td> </tr> <tr> <td>G - 41 H - 42 I - 43 4 - 40</td> <td>J - 51 K - 52 L - 53 5 - 50</td> <td>M - 61 N - 62 O - 63 6 - 60</td> </tr> <tr> <td>P - 71 R - 72 S - 73 Q - 7* 7 - 70</td> <td>T - 81 U - 82 V - 83 8 - 80</td> <td>W - 91 X - 92 Y - 93 Z - 9# 9 - 90</td> </tr> <tr> <td>*1 - Blank *2 - : *3 - ,</td> <td>0-00</td> <td>#</td> </tr> </tbody> </table> <ul style="list-style-type: none"> <li>• Press <b>HOLD/SAVE</b> button.</li> </ul>		Q - 11 Z - 12 . - 13 1 - 10	A - 21 B - 22 C - 23 2 - 20	D - 31 E - 32 F - 33 3 - 30	G - 41 H - 42 I - 43 4 - 40	J - 51 K - 52 L - 53 5 - 50	M - 61 N - 62 O - 63 6 - 60	P - 71 R - 72 S - 73 Q - 7* 7 - 70	T - 81 U - 82 V - 83 8 - 80	W - 91 X - 92 Y - 93 Z - 9# 9 - 90	*1 - Blank *2 - : *3 - ,	0-00
Q - 11 Z - 12 . - 13 1 - 10	A - 21 B - 22 C - 23 2 - 20	D - 31 E - 32 F - 33 3 - 30											
G - 41 H - 42 I - 43 4 - 40	J - 51 K - 52 L - 53 5 - 50	M - 61 N - 62 O - 63 6 - 60											
P - 71 R - 72 S - 73 Q - 7* 7 - 70	T - 81 U - 82 V - 83 8 - 80	W - 91 X - 92 Y - 93 Z - 9# 9 - 90											
*1 - Blank *2 - : *3 - ,	0-00	#											
<p><b>In Aria-16/20/20W</b></p> <ul style="list-style-type: none"> <li>• Pressing [▼] key while entering name, the last character will be erased.</li> </ul>													



## Call Park

A call can be parked in a parking location and the call will be retrieved by dialing the location number. (The call can be picked up by other extension with making a page announcement to inform the parking location.)

Button	Procedures	Range
	<p>While connected to an outside call,</p> <ul style="list-style-type: none"> <li>• Press <b>TRANS/PGM</b> button.</li> <li>• Dial <u>parking location</u>.</li> </ul>	<p>Aria-300:601~619                      Aria-130:601~610                      186 : 601~619                      100 : 601~610                      34e: 601~605                      16/20W: 601~606                      (16: Above V4.0,                      20W: Above V3.0)</p>
<i>Or using display, (Only in KD-33LD, KD/E-36LD, LKD-30LD)</i>		
	<ul style="list-style-type: none"> <li>• Press the 4th menu key from main menu and you will see the following on the display.</li> </ul> <div style="border: 1px solid black; padding: 5px; margin: 10px 0;"> <ul style="list-style-type: none"> <li>▪ INT PAGE (01-20)   ▪</li> <li>▪ INT ALL CALL       ▪</li> <li>▪ EXT ALL CALL       ▪</li> <li>▪ INT/EXT ALL CALL   ▪</li> <li>▪ MEET ME            ▪</li> <li>.....</li> <li>  STA 102 (T)        ▲</li> <li>  NOV 02 01:40pm   ▼</li> </ul> </div> <ul style="list-style-type: none"> <li>• Press <b>PAGE</b> down(▼) key, and you will see the following on the display.</li> </ul> <div style="border: 1px solid black; padding: 5px; margin: 10px 0;"> <ul style="list-style-type: none"> <li>▪ CALL PARK (01-19)   ▪</li> <li>▪ GROUP PICKUP        ▪</li> <li>▪ DIR PICKUP (STA#)   ▪</li> <li>.....</li> <li>  STA 102 (T)        ▲</li> <li>  NOV 02 01:40pm   ▼</li> </ul> </div> <ul style="list-style-type: none"> <li>• Select <b>CALL PARK</b>.</li> </ul> <p><i>To retrieve a parked call,</i></p> <ul style="list-style-type: none"> <li>• Lift handset or press <b>MON</b> button.</li> <li>• Dial <u>parking location</u>.</li> </ul>	
		

## Universal Night Answer ( \* )

When CO lines are programmed for UNA and the system is placed into night mode, users can answer incoming CO line calls employing dial code regardless of pick-up group.

Button	Procedures	Range
	<ul style="list-style-type: none"> <li>• Lift handset or press <b>MON</b> button.</li> <li>• Press flashing CO line button. If a CO line button is not assigned, dial <b>77</b>. (<i>Aria-300/130: dial 577 Aria 20: 69</i>)</li> <li>• You will be connected to ringing outside line.</li> </ul>	



**Universal Night Answer (Cont'd)**

Button	Procedures	Range
<p>Or using display, (<i>Only in KD-33LD, KD/E-36LD, LKD-30LD</i>)</p>	<ul style="list-style-type: none"> <li>Press the 4th menu key from main menu and you will see the following on the display.                             <div data-bbox="416 501 692 719" style="border: 1px solid black; padding: 5px; margin: 10px 0;"> <ul style="list-style-type: none"> <li>▪ INT PAGE (01-20)   ▪</li> <li>▪ INT ALL CALL       ▪</li> <li>▪ EXT ALL CALL       ▪</li> <li>▪ INT/EXT ALL CALL   ▪</li> <li>▪ MEET ME            ▪</li> <li>.....</li> <li>  STA 102 (T)        ▲</li> <li>  NOV 02 01:40pm   ▼</li> </ul> </div> </li> <li>Press <b>PAGE</b> down(▼) key twice, and you will see the following on the display.                             <div data-bbox="416 824 1066 1077" style="display: flex; justify-content: space-around;"> <div data-bbox="416 824 692 1041" style="border: 1px solid black; padding: 5px;"> <ul style="list-style-type: none"> <li>▪ ACC CO-GR (01-48)   ▪</li> <li>▪ ACC 1 CO (01-96)   ▪</li> <li>▪ UNIV NITE ANSWER   ▪</li> <li>▪ TIE ROUTE (01-30)  ▪</li> <li>▪ ALARM RESET        ▪</li> <li>.....</li> <li>  STA 102 (T)        ▲</li> <li>  NOV 02 01:40pm   ▼</li> </ul> </div> <div data-bbox="791 824 1066 1041" style="border: 1px solid black; padding: 5px;"> <ul style="list-style-type: none"> <li>▪ ACC 1 CO (1-200)   ▪</li> <li>▪ ACC CO_GR(01-72)   ▪</li> <li>▪ TIE ROUTE(01-30)   ▪</li> <li>▪ CALL PARK(01-19)   ▪</li> <li>▪ UNIV NITE ANSWER   ▪</li> <li>.....</li> <li>  STA 102 (T)        ▲</li> <li>  NOV 02 01:40pm   ▼</li> </ul> </div> </div> <p style="text-align: center; margin-top: 5px;">&lt; Aria-300/130 &gt;</p> </li> <li>Select UNIV ANSWER(UNIV NITE ANSWER in Aria-300/130) key.                              If an outside line is assigned for UNA and the attendant station is placed into night service mode, you will be connected to ringing outside line.                         </li> </ul>	



CO Line Features

**Changing Intercom Answer Mode**

Button	Procedures	Range
<p><i>TRANS/PGM</i> </p> <p><i>HOLD/SAVE</i> </p>	<ul style="list-style-type: none"> <li>Press <b>TRANS/PGM</b> button.</li> <li>Dial <b>4 9</b> (<i>Aria-300/130: 1 2</i>).</li> <li>Dial 1 for Handsfree, 2 for Tone ring, or 3 for Privacy announce.</li> <li>Press <b>HOLD/SAVE</b> button.</li> </ul>	

### Placing an Intercom Call

Button	Procedures	Range
	<ul style="list-style-type: none"> <li>• Dial intercom number or press programmed DSS button.</li> <li>• You will hear,                             <ul style="list-style-type: none"> <li>- Ring back tone in TN (Tone) mode. Wait for called station to answer the ringing.</li> <li>- 3 bursts of tone in HF(Handsfree) or PV(Privacy) mode. Begin your announcement after the tone.</li> </ul> </li> </ul>	



### Answering an Intercom Call

Button	Procedures	Range
	<ul style="list-style-type: none"> <li>• With your intercom answer mode setting,                             <ul style="list-style-type: none"> <li>- in TN mode, intercom ring is heard. Lift handset to talk.</li> <li>- in PV mode, 3 bursts of tone and one-way announcement is heard. Lift handset to talk.</li> <li>- in HF mode, 3 bursts of tone and announcement is heard. Reply with handsfree mode or lift handset for privacy.</li> </ul> </li> </ul>	

### Placing an Intercom on Hold ( \* )

Button	Procedures	Range
	<ul style="list-style-type: none"> <li>• If your phone has <b>ICM</b> button, you may put an intercom call on hold by pressing <b>HOLD/SAVE</b> button.</li> <li>• Or, while on an intercom call, press <b>ICM</b> button.</li> <li>• The ICM button flashes and intercom dial tone will be heard.</li> </ul> <p><i>To retrieve intercom call on hold,</i></p> <ul style="list-style-type: none"> <li>• Press the flashing ICM button and lift handset.</li> </ul>	

## Changing Differential Ring

Button	Procedures	Range
  	<ul style="list-style-type: none"> <li>• Press <b>TRANS/PGM</b> button.</li> <li>• Dial <b>5 0</b> (<i>Aria-300/130 : 1 1</i>).</li> <li>• Select the ring type by dialing 1~4.</li> <li>• Press <b>HOLD/SAVE</b> button.</li> </ul> <p><i>Or using display, (Only in KD-33LD, KD/E-36LD, LKD-30LD)</i></p> <ul style="list-style-type: none"> <li>• Press the 5th menu key from main menu to select PROGRAM. and you'll see the following on the display.</li> </ul> <div style="border: 1px solid black; padding: 5px; margin: 10px 0;"> <ul style="list-style-type: none"> <li>▪ ATD PROGRAM</li> <li>▪ STATIONPROGRAM</li> <li>▪ LCD BRIGHTNESS</li> <li>▪ RING VOLUME</li> <li>▪ SPEAKER VOLUME</li> <li>.....</li> <li>  STA 102 (T)   ▲</li> <li>▣ NOV 02 01:40pm ▼</li> </ul> </div> <ul style="list-style-type: none"> <li>• Select STATION PROGRAM.</li> </ul> <p>On the display, you will see the following.</p> <div style="display: flex; justify-content: space-around;"> <div style="border: 1px solid black; padding: 5px; margin: 10px 0;"> <ul style="list-style-type: none"> <li>▪ S&gt;WAKE-UP SET</li> <li>▪ S&gt;WAKE-UP ERASE</li> <li>▪ S&gt;REG PASSWORD</li> <li>▪ S&gt;CHG PASSWORD</li> <li>▪ S&gt;INTERCOM ONLY</li> <li>.....</li> <li>  STA 102 (T)   ▲</li> <li>▣ NOV 02 01:40pm ▼</li> </ul> </div> <div style="border: 1px solid black; padding: 5px; margin: 10px 0;"> <ul style="list-style-type: none"> <li>▪ S&gt;RING TYPE</li> <li>▪ S&gt;ANSWER MODE</li> <li>▪ S&gt;COS DOWN</li> <li>▪ S&gt;RESTORE COS</li> <li>▪ S&gt;WALKING COS</li> <li>.....</li> <li>  STA 102 (T)   ▲</li> <li>▣ NOV 02 01:40pm ▼</li> </ul> </div> </div> <p style="text-align: center; margin: 5px 0;">&lt; Aria-300/130 &gt;</p> <ul style="list-style-type: none"> <li>• Press <b>PAGE</b> down(▼) key twice.</li> </ul> <p>On the display, you will see the following.</p> <div style="display: flex; justify-content: space-around;"> <div style="border: 1px solid black; padding: 5px; margin: 10px 0;"> <ul style="list-style-type: none"> <li>▪ S&gt;DIFFER RING</li> <li>▪ <u>LGE/GS86P-5.5Ca</u></li> <li>.....</li> <li>  STA 102 (T)   ▲</li> <li>▣ NOV 02 01:40pm ▼</li> </ul> </div> <div style="border: 1px solid black; padding: 5px; margin: 10px 0;"> <ul style="list-style-type: none"> <li>▪ S&gt;RING TYPE</li> <li>▪ S&gt;ANSWER MODE</li> <li>▪ S&gt;COS DOWN</li> <li>▪ S&gt;RESTORE COS</li> <li>▪ S&gt;WALKING COS</li> <li>.....</li> <li>  RING TYPE</li> <li>  1~4 : 1</li> </ul> </div> </div> <p style="text-align: center; margin: 5px 0;">&lt; Aria-300/130 &gt;</p> <ul style="list-style-type: none"> <li>• Select DIFFER RING key.</li> <li>• Select the ring type (1~4) by pressing dial button 1~4.</li> <li>• Press <b>HOLD/SAVE</b> button.</li> </ul>	

Intercom Features

## Voice Over ( \* )

This feature provides voice announcement to a busy station without interrupting the existing conversation. The announcement is received over the existing conversation so that only the busy station hears both incoming parties.

Button	Procedures	Range
 HOLD/SAVE	<ul style="list-style-type: none"> <li>When a busy keyset engaged in an internal or external call is called through camp-on by a caller, <b>HOLD/SAVE</b> button of busy keyset is flashing. After tone, the busy keyset can be connected to both parties.</li> <li>Press <b>HOLD/SAVE</b> button in the busy keyset to converse with new call.</li> <li>Press <b>HOLD/SAVE</b> button again to alternate the call.</li> </ul>	

## Answering a Call Wait with Voice Over

Button	Procedures	Range
 HOLD/SAVE	<ul style="list-style-type: none"> <li>You hear camp-on tone and <b>HOLD/SAVE</b> button is flashing.</li> <li>Press <b>HOLD/SAVE</b> button to talk with the second caller. The first caller is placed on hold. (MOH may be provided)</li> <li>You will be connected to the first caller when the second caller hangs up.</li> </ul>	<i>Aria-16/20W:</i> The previous internal call will be disconnected. The previous external call will be on hold.

## Directed Call Pick-up

Button	Procedures	Range
 MON	<ul style="list-style-type: none"> <li>You hear intercom or transferred outside line ring at a station.</li> <li>Lift handset or press <b>MON</b> button.</li> <li>Dial <b>7</b> and the ringing <u>station number</u>.</li> <li>You will be connected to the calling party.</li> </ul>	Aria-300:100~399 Aria-130:100~227 186 : 100~291 100 : 100~235 34e : 100~177 16 : 100~ 115 20: 100~ 121 20W : 100~133 (16: Above V4.0 20W: Above V3.0)
	<p><i>Or using display, (Only in KD-33LD, KD/E-36LD, LKD-30LD)</i></p> <ul style="list-style-type: none"> <li>Press the 4th menu key from the main menu.</li> <li>Select DIR.PICKUP (STA#) and dial the ringing <u>station number</u>.</li> <li>You will be connected to calling party automatically.</li> </ul>	

### Call Wait (Camp-on)

If you dial a busy station, you may alert it of your call.

Button	Procedures	Range
	<ul style="list-style-type: none"> <li>• After receiving intercom busy tone, dial “*” or last digit of called station number, or press DSS button.</li> <li>• Camp-on tone is heard in called station.</li> <li>• When called party answers, talk or hang up to transfer the call.</li> </ul>	



### Mute

It provides privacy during speakerphone or handset operation by disabling the microphone.

Button	Procedures	Range
	<ul style="list-style-type: none"> <li>• Press <b>MUTE</b> button to activate.</li> <li>• Press <b>MUTE</b> button again to deactivate.</li> </ul>	



### Call Back

If you dial a station that is busy, you can leave a callback indication.

Button	Procedures	Range
	<ul style="list-style-type: none"> <li>• After receiving intercom busy tone, press <b>CALLBK</b> button.</li> <li>• Hang up.</li> <li>• When the busy station hangs up, you will be signaled.</li> <li>• Answer the signal by lifting handset or by pressing <b>MON</b> button, the station you called will be signaled.</li> </ul>	
		

## Message Waiting

When the called extension does not answer the call, you can leave a message wait to the station.





Button	Procedures	Range
	<ul style="list-style-type: none"> <li>• If a called party does not answer, press <b>CALLBK</b> button.</li> <li>• Hang up.</li> <li>• At that time, the LED of CALLBK button in the called station is flashing.</li> </ul>	
<p><i>On LKD-2N/S, 8D/S,</i></p>		
	<ul style="list-style-type: none"> <li>• If a called party does not answer, press <b>TRANS/PGM</b> button and dial <b>5 6</b> . (<i>Aria-300/130: 5 5 6</i>)</li> </ul>	
	<p><i>To answer a message waiting,</i></p> <ul style="list-style-type: none"> <li>• Press flashing <b>CALLBK</b> button.</li> <li>• Station that left message will be signaled with tone ring.</li> </ul>	
<p><i>On LKD-2N/S, 8D/S,</i></p>		
	<ul style="list-style-type: none"> <li>• Dial <b>5 7</b> (<i>Aria-300/130: 5 5 7</i>) to answer a message waiting.</li> </ul>	

## Do Not Disturb

Button	Procedures	Range
	<p>If your phone has been programmed to have Do Not Disturb,</p> <ul style="list-style-type: none"> <li>• Press <b>DND/FWD</b> button while on-hook or your phone is ringing.</li> <li>• The LED is lighting and your phone is in DND.</li> </ul> <p><i>To remove Do Not Disturb,</i></p> <ul style="list-style-type: none"> <li>• Press <b>DND/FWD</b> button while on-hook.</li> <li>• The LED is extinguished and DND at your phone is removed.</li> </ul>	
<p><i>On LKD-2N/S, 8D/S,</i></p>		
	<ul style="list-style-type: none"> <li>• Dial <b>5 3</b> (<i>Aria-300/130: 5 5 3</i>) instead of pressing <b>DND/FWD</b> button (Toggle setting).</li> </ul>	

## Call Forward

A call can be forwarded to the other station or group depending on the call forward type. It should be programmed in Admin. Programming to use some of the Call Forward types.



Button	Procedures	Range
 MON  DND/FWD	<ul style="list-style-type: none"> <li>• Lift handset or press <b>MON</b> button. (The <b>MON</b> button is lighting.)</li> <li>• Press <b>DND/FWD</b> button.</li> <li>• Press the call forward type;                             <ul style="list-style-type: none"> <li><b>0 - Follow me (not available in Aria-16/20W)</b></li> <li><b>1 - Unconditional</b></li> <li><b>2 - Busy calls</b></li> <li><b>3 - No answer calls</b></li> <li><b>4 - Busy / no answer calls</b></li> <li><b>5 - Station off-net</b></li> <li><b>6 - Incoming outside line to off-net (system attendant only)</b></li> <li><b>7 - DVU forward - 1 (forwarded after 4sec)</b></li> <li><b>8 - DVU forward - 2 (forwarded after predefined time)</b></li> <li><b>9 - DVU forward for busy</b></li> </ul> </li> <li>• Dial <u>station number</u> or press DSS button or <u>intercom group</u>.</li> <li>• Aria-16/20W can be available to the type 1-7 only.</li> <li>• Confirmation tone is heard and <b>DND/FWD</b> button is flashing on forwarded station.</li> <li>• Hang up.</li> </ul> <p>- In case <i>Follow-me</i>, it should be programmed from the station that you will be forwarded to i.e. if your extension is 102 and you are forwarding to 104, then you will need to go to 104 to program the feature. Also, this feature requires authorization code and requires system programming.</p> <p>- In case <i>Station Off-net</i>, the number you are forwarding to should be saved as a speed dial number first. (Please see the Page 12 to save a Speed Dial Number.)</p> <p>- In case <i>Incoming outside line to Off-net</i>, it requires system programming.</p> <p>- In <i>Aria-16/20W</i>, 1 DVIB Forward(busy/no answer) is available. (<b>DND/FWD + dial 7</b>; in no answer case, the forwarding time can be programmed with Admin Programming.)</p> <p><i>To cancel call forward,</i></p> <ul style="list-style-type: none"> <li>• Lift handset or press <b>MON</b> button.</li> <li>• Press <b>DND/FWD</b> button and dial <b>#</b>.</li> <li>• Hang up.</li> </ul> <p>- To cancel Incoming Outside line to Off-net (at system attendant), Press <b>MON + DND/FWD + CO line code (CO group/CO line no. /CO BTN) + #</b></p>	<p><i>Sta. No.</i></p> <p>186 : 100~291                      100 : 100~235                      34e : 100~177                      16 : 100~115                      20: 100~121                      20W: 100~133</p> <p><i>INT. Group</i></p> <p>186 : 620~649                      100 : 620~634                      34e : 620~627                      16/20W : 61~64</p>
 MON  DND/FWD	<p>On LKD-2N/S, 8D/S,</p> <ul style="list-style-type: none"> <li>• Dial <b>5 4</b> instead of pressing <b>DND/FWD</b> button.</li> <li><i>To Cancel</i> : Dial <b>5 4 #</b></li> </ul>	

Intercom Features



## Call Forward (Aria-300/130)

A call can be forwarded to the other station, station group or VMIB depending on the call forward type. It should be programmed in Admin. Programming to use some of the Call Forward types.

Button	Procedures	Range
	<ul style="list-style-type: none"> <li>Lift handset or press <b>MON</b> button. (The <b>MON</b> button is lighting.)</li> <li>Press <b>DND/FWD</b> button.</li> <li>Press the call forward type;                             <ul style="list-style-type: none"> <li><b>0 - Follow me</b></li> <li><b>1 - Unconditional</b></li> <li><b>2 - Busy calls</b></li> <li><b>3 - No answer calls</b></li> <li><b>4 - Busy / no answer calls</b></li> <li><b>5 - Station off-net, Unconditional</b></li> <li><b>6 - Station off-net, No Answer</b></li> <li><b>7 - Incoming outside line to off-net (Attendant only)</b></li> </ul> </li> <li>Dial <u>station number</u> or press DSS button or <u>intercom group</u>.</li> <li>Confirmation tone is heard and <b>DND/FWD</b> button is flashing on forwarded station.</li> <li>Hang up.</li> </ul> <p><i>To activate call forward to VMIB,</i></p> <ul style="list-style-type: none"> <li>Lift handset or press <b>MON</b> button.</li> <li>Press <b>DND/FWD</b> button.</li> <li>Dial desired Call Forward code (1~4).</li> <li>Dial VMIB selection code # to receive the call.</li> <li>Hang up.</li> </ul> <p>- In case <i>Follow-me</i>, it should be programmed from the station that you will be forwarded to i.e. if your extension is 102 and you are forwarding to 104, then you will need to go to 104 to program the feature. Also, this feature requires authorization code and requires system programming.</p> <p>- In case <i>Station Off-net</i>, the number you are forwarding to should be saved as a speed dial number first. (Please see the Page 12 to save a Speed Dial Number.)</p> <p>- In case <i>Incoming outside line to Off-net</i>, it requires system programming.</p>	<p><i>Sta. No.</i>                      Aria-300 : 100~399                      Aria-130 : 100~227</p> <p><i>INT. Group</i>                      Aria-300 : 620~667                      Aria-130 : 620~634</p>
	<p><i>To cancel call forward,</i></p> <ul style="list-style-type: none"> <li>Lift handset or press <b>MON</b> button.</li> <li>Press <b>DND/FWD</b> button and dial #.</li> <li>Hang up.</li> </ul> <p>- To cancel Incoming Outside line to Off-net (at system attendant), Press <b>MON + DND/FWD + CO line code (CO group/CO line no. /CO BTN) + #</b></p>	
<p>On LKD-2N/S, 8D/S,</p>		
	<ul style="list-style-type: none"> <li>Dial <b>5 5 4</b> instead of pressing <b>DND/FWD</b> button.</li> </ul> <p><i>To Cancel : Dial 5 5 4 #</i></p>	

## Paging

A station, which is allowed to access page facilities, can connect and transmit voice announcement to any or all of the system external/internal page zones.

Button	Procedures						Range
	To make a page, <ul style="list-style-type: none"> <li>• Lift handset.</li> <li>• Dial page zone. (See below chart.) And you will hear warning tone.</li> <li>• After the tone, speak your message.</li> <li>• Hang up.</li> </ul>						
	186	100	34e	16/20W	Aria-300	Aria-130	
All Call	# 0 0	# 0 0	# 0 0	# 0	# 0 0	# 0 0	
Internal Zone 1	# 0 1	# 0 1	# 0 1	# 1	# 0 1	# 0 1	
Internal Zone 2	# 0 2	# 0 2	# 0 2	# 2	# 0 2	# 0 2	
:	:	:	:	N.A.	:	:	
Internal Zone 5	# 0 5	# 0 5	# 0 5		# 0 5	# 0 5	
:	:	:			:	:	
Internal Zone 15	# 1 5	# 1 5			# 1 5	# 1 5	
:	:						
Internal Zone 20	# 2 0						
Internal Zone 35					# 3 5		
Internal All Call	# 3	# 3	# 3	# #	# 3	# 3	
External Zone 1	# 6	# 6	# 6	N.A	# 5	# 5	
External Zone 2	# 7	# 7			# 6	# 6	
External Zone 3					# 7	# 7	
External All Call	# 8	# 8	# 8	# 3	# 8	# 8	

Or using display, **(Only in KD-33LD, KD/E-36LD, LKD-30LD)**

*For internal zone,*

- Press the 4th menu key from main menu and you will see the following on the display.

<ul style="list-style-type: none"> <li>■ INT PAGE (01-20)</li> <li>■ INT ALL CALL</li> <li>■ EXT ALL CALL</li> <li>■ INT/EXT ALL CALL</li> <li>■ MEET ME</li> </ul> <hr style="border-top: 1px dashed black;"/> <p style="text-align: center;">STA 102 (T)</p> <p style="text-align: center;">NOV 02 01:40pm</p>	▲		▼			<ul style="list-style-type: none"> <li>■ INT PAGE (01-35)</li> <li>■ INT ALL CALL</li> <li>■ EXT PAGE 1</li> <li>■ EXT PAGE 2</li> <li>■ EXT PAGE 3</li> </ul> <hr style="border-top: 1px dashed black;"/> <p style="text-align: center;">STA 102 (T)</p> <p style="text-align: center;">NOV 02 01:40pm</p>
< Aria-300/130 >						

- Select INT PAGE key.
- Dial the desired zone. (Confirmation tone is heard.)
- After the tone, speak your message.

*For internal all call/external all call/all call,*

- Press the 4th menu key from main menu and you will see the following on the display.

<ul style="list-style-type: none"> <li>■ INT PAGE (01-20)</li> <li>■ INT ALL CALL</li> <li>■ EXT ALL CALL</li> <li>■ INT/EXT ALL CALL</li> <li>■ MEET ME</li> </ul> <hr style="border-top: 1px dashed black;"/> <p style="text-align: center;">STA 102 (T)</p> <p style="text-align: center;">NOV 02 01:40pm</p>	▲		▼			<ul style="list-style-type: none"> <li>■ INT PAGE (01-35)</li> <li>■ INT ALL CALL</li> <li>■ EXT PAGE 1</li> <li>■ EXT PAGE 2</li> <li>■ EXT PAGE 3</li> </ul> <hr style="border-top: 1px dashed black;"/> <p style="text-align: center;">STA 102 (T)</p> <p style="text-align: center;">NOV 02 01:40pm</p>
< Aria-300/130 >						

Aria-300:01~35  
 Aria-130:01~15  
 186 : 01~20  
 100 : 01~15  
 34e : 01~05

Aria-300:01~35  
 Aria-130:01~15  
 186 : 01~20  
 100 : 01~15  
 34e : 01~05

Intercom Features

**Paging (Cont'd)**

Button	Procedures	Range
	<ul style="list-style-type: none"> <li>• Select the desired page key. (INT ALL CALL/EXT ALL CALL/INT/EXT ALL CALL)</li> <li>• You will hear warning tone.</li> <li>• After the tone, speak your message.</li> </ul> <p><i>To answer paging,</i></p> <ul style="list-style-type: none"> <li>• Go to the nearest key telephone.</li> <li>• Lift handset and dial <b>4 4</b>(Aria-16/20W: <b># 6</b>, Aria-300/130:<b>5 4 4</b>) or <b>HOLD/SAVE</b> button, and you will be connected to the paging party.</li> </ul>	
<p><i>Or using display, (Only in KD-33LD, KD/E-36LD, LKD-30LD)</i></p>		
	<ul style="list-style-type: none"> <li>• Press the 4th menu key from main menu and you will see the following on the display.</li> </ul> <div data-bbox="443 831 691 1055" style="border: 1px solid black; padding: 5px; margin: 10px 0;"> <pre> INT PAGE (01-20) INT ALL CALL EXT ALL CALL INT/EXT ALL CALL MEET ME ----- STA 102 (T) NOV 02 01:40pm                     </pre> </div> <ul style="list-style-type: none"> <li>• Select MEET ME and you will be connected to paging party.</li> </ul>	<p>Aria-300:01~35 Aria-130:01~15 186 : 01~20 100 : 01~15 34e : 01~05</p>
<p><i>In Aria-300/130, (Only in KD-33LD, KD/E-36LD, LKD-30LD)</i></p>		
	<div data-bbox="443 1216 691 1440" style="border: 1px solid black; padding: 5px; margin: 10px 0;"> <pre> INT PAGE (01-35) INT ALL CALL EXT PAGE 1 EXT PAGE 2 EXT PAGE 3 ----- STA 102 (T) NOV 02 01:40pm                     </pre> </div> <div data-bbox="826 1216 1074 1440" style="border: 1px solid black; padding: 5px; margin: 10px 0;"> <pre> EXT ALL CALL INT/EXT ALL CALL MEET ME ----- STA 102 (T) NOV 02 01:40pm                     </pre> </div> <p style="text-align: center; margin: 5px 0;">&lt; Aria-300/130 &gt;</p> <ul style="list-style-type: none"> <li>• Select MEET ME and you will be connected to paging party.</li> </ul>	

**Flash**

Disconnects outside line and reseizes dial tone. It can be used to send a timed break recall when the system is connected with a PBX.



Button	Procedures	Range
	<ul style="list-style-type: none"> <li>• While connected to an outside line, press <b>FLASH</b> button.</li> </ul>	

## Speakerphone



Pressing an outside line button, a speed button, a station button or dialing a station number will automatically activate the speakerphone. (LKD-2N/S has no microphone and doesn't function as handsfree unit.)

Button	Procedures	Range
	To activate speakerphone, <ul style="list-style-type: none"> <li>• Press <b>MON</b> button.</li> <li>• Dial outside line number or intercom number to talk.</li> </ul>	

## Speaker Volume Control

Button	Procedures	Range
	<ul style="list-style-type: none"> <li>• In speakerphone mode, press <b>VOLUME</b> (▲/▼) button to control the speakerphone volume.</li> </ul>	
<i>Or using display, (Only in KD-33LD, KD/E-36LD, LKD-30LD)</i>		
	<ul style="list-style-type: none"> <li>• Press the 5th menu key from main menu to select PROGRAM.</li> <li>• Select SPEAKER VOLUME.</li> <li>• Press <b>VOLUME</b> (▲/▼) button to control speaker volume.</li> </ul>	

## Ring Volume Control

Button	Procedures	Range
	<ul style="list-style-type: none"> <li>• When bell rings, press <b>VOLUME</b> (▲/▼) button to control ring volume.</li> </ul>	
<i>Or using display, (Only in KD-33LD, KD/E-36LD, LKD-30LD)</i>		
	<ul style="list-style-type: none"> <li>• Press the 5th menu key from main menu to select PROGRAM.</li> <li>• Select RING VOLUME.</li> <li>• Press <b>VOLUME</b> (▲/▼) button to control ring volume.</li> </ul>	

Intercom Features

## Placing an Intercom Group Call

Button	Procedures	Range
 MON	<p><i>To make an intercom group call,</i></p> <ul style="list-style-type: none"> <li>• Lift handset or press <b>MON</b> button.</li> <li>• Dial the <u>intercom group number</u>.</li> </ul>	<p><i>INT. Group No.</i>                      Aria-300:620~667                      Aria-130:620~634                      186 : 620 ~ 649                      100 : 620 ~ 634                      34e : 620 ~ 627                      16/20W : 61~64</p>

## Placing a CO Call on Hold

Button	Procedures	Range
 HOLD/SAVE	<ul style="list-style-type: none"> <li>• Press <b>HOLD/SAVE</b> button.                             <ul style="list-style-type: none"> <li>- Once for system hold</li> <li>- Twice for exclusive hold (N/A Aria-16/20/20W)</li> </ul>                             Reverse if hold preference is programmed to system hold.                         </li> <li>• Press <b>HOLD/SAVE</b> button (in Aria-16/20W).                              CO call will be put on hold according to the Hold Preference.</li> </ul> <p><i>To retrieve the call,</i></p> <ul style="list-style-type: none"> <li>• Lift handset and press flashing outside line button.</li> </ul>	

## Group Call Pick-up

Button	Procedures	Range
 MON	<p>You should be in the same pick-up group as ringing phone.</p> <ul style="list-style-type: none"> <li>• You hear an unattended phone ringing.</li> <li>• Lift handset or press <b>MON</b> button.</li> <li>• Dial <b>6 6</b> (<i>Aria-300/130 : 5 6 6</i>).</li> </ul>	

*Or using display, (Only in KD-33LD, KD/E-36LD, LKD-30LD)*

 MON	<ul style="list-style-type: none"> <li>• Press the 4th menu key from the main menu.</li> </ul> <div style="display: flex; justify-content: space-around; align-items: center;"> <div style="border: 1px solid black; padding: 5px; width: 40%;"> <ul style="list-style-type: none"> <li>■ INTERCOM CALL ■</li> <li>■ STATION SPD DIAL ■</li> <li>■ SYSTEM SPD DIAL ■</li> <li>■ FEATURE ■</li> <li>■ PROGRAM ■</li> <li>-----</li> <li style="text-align: center;">STA 102 (T) ▲</li> <li>■ NOV 02 01:40pm ▼ ■</li> </ul> </div> <div style="font-size: 2em;">▶</div> <div style="border: 1px solid black; padding: 5px; width: 40%;"> <ul style="list-style-type: none"> <li>■ INT PAGE (01-20) ■</li> <li>■ INT ALL CALL ■</li> <li>■ EXT ALL CALL ■</li> <li>■ INT/EXT ALL CALL ■</li> <li>■ MEET ME ■</li> <li>-----</li> <li style="text-align: center;">STA 102 (T) ▲</li> <li>■ NOV 02 01:40pm ▼ ■</li> </ul> </div> </div> <ul style="list-style-type: none"> <li>• Pressing <b>PAGE</b> down(▼) key, you will see the following.</li> </ul> <div style="border: 1px solid black; padding: 5px; width: 40%; margin-top: 10px;"> <ul style="list-style-type: none"> <li>■ CALL PARK (01-19) ■</li> <li>■ GROUP PICKUP ■</li> <li>■ DIR PICKUP (STA#) ■</li> <li>■ ■</li> <li>■ ■</li> <li>-----</li> <li style="text-align: center;">STA 102 (T) ▲</li> <li>■ NOV 02 01:40pm ▼ ■</li> </ul> </div> <ul style="list-style-type: none"> <li>• Select the <b>GROUP PICKUP</b>. You will be connected to the calling party automatically.</li> </ul>	
--	---	--



## Group Call Pick-up (Cont'd)

Button	Procedures	Range
	<p><i>In Aria-300/130, (Only in KD-33LD, KD/E-36LD, LKD-30LD)</i></p> <ul style="list-style-type: none"> <li>Press the 4th menu key from the main menu.</li> </ul> <div style="display: flex; justify-content: space-around; align-items: center;"> <div style="border: 1px solid black; padding: 5px; width: 45%;"> <ul style="list-style-type: none"> <li>■ INTERCOM CALL ■</li> <li>■ STATION SPD DIAL ■</li> <li>■ SYSTEM SPD DIAL ■</li> <li>■ FEATURE ■</li> <li>■ PROGRAM ■</li> <li>-----</li> <li>■ STA 102 (T) ▲</li> <li>■ NOV 02 01:40pm ▼</li> </ul> </div> <div style="font-size: 2em; margin: 0 10px;">▶</div> <div style="border: 1px solid black; padding: 5px; width: 45%;"> <ul style="list-style-type: none"> <li>■ INT PAGE (01-35) ■</li> <li>■ INT ALL CALL ■</li> <li>■ EXT PAGE 1 ■</li> <li>■ EXT PAGE 2 ■</li> <li>■ EXT PAGE 3 ■</li> <li>-----</li> <li>■ STA 102 (T) ▲</li> <li>■ NOV 02 01:40pm ▼</li> </ul> </div> </div> <ul style="list-style-type: none"> <li>Pressing <b>PAGE</b> down(▼) key 3 times, you will see the following.</li> </ul> <div style="border: 1px solid black; padding: 5px; width: 45%; margin-bottom: 10px;"> <ul style="list-style-type: none"> <li>■ GROUP PCIKUP ■</li> <li>■ DIR PICKUP (STA#) ■</li> <li>■ ALARM RESET ■</li> <li>■ DOOR OPEN (1-7) ■</li> <li>■ ■</li> <li>-----</li> <li>■ STA 102 (T) ▲</li> <li>■ NOV 02 01:40pm ▼</li> </ul> </div> <ul style="list-style-type: none"> <li>Select the <b>GROUP PICKUP</b>. You will be connected to the calling party automatically.</li> </ul>	

## Conference



Button	Procedures	Range
	<p><i>To establish a conference,</i></p> <ul style="list-style-type: none"> <li>Call desired party. (internal or outside)</li> <li>Press <b>CONF</b> button. (<b>CONF</b> button is lighting and the called party is put on exclusive hold.)</li> <li>Call the next party.</li> <li>Press <b>CONF</b> button twice. (once if adding additional parties)</li> <li>Conference is established.</li> </ul> <p><i>To add another party in the conference, (not available in Aria-16/20W)</i></p> <ul style="list-style-type: none"> <li>Press <b>CONF</b> button.</li> <li>Call the next party.</li> <li>Press <b>CONF</b> button twice.</li> </ul> <p><i>To exit a conference (unsupervised),</i></p> <ul style="list-style-type: none"> <li>Press <b>CONF</b> button in the supervisor station and hang up. Other parties are still connected.</li> </ul>	<p><i>Aria-16/20W:</i> At most 3 parties can be active in a conference.</p>

## Conference (Cont'd)

Button	Procedures	Range
	<p><i>Re-entering a conference,</i></p> <ul style="list-style-type: none"> <li>• Lift handset or press <b>MON</b> button.</li> <li>• Press <b>CONF</b> button.</li> </ul>	
	<p><i>To drop an outside party, (not available in Aria-16/20W) (You should be active in the conference.)</i></p> <ul style="list-style-type: none"> <li>• Press outside line of party you wish to drop.</li> <li>• Hang up or press <b>MON</b> button.</li> </ul> <p><i>To terminate the conference,</i></p> <ul style="list-style-type: none"> <li>• Hang up or, press <b>CONF</b> button if unsupervised.</li> </ul>	
<p><i>On LKD-2N/S, 8D/S,</i></p> <ul style="list-style-type: none"> <li>• Conference feature can be accomplished by programming a flexible key as <b>CONF</b> button (TRANS + 91).</li> </ul>		

## Access Authorization Code ( \* )

To prevent unauthorized outside calling, DISA access or Trunk access on your station by others, the system provides a means to lock/unlock a station by access authorization code.

Button	Procedures	Range
 	<p><i>To register access authorization code,</i></p> <ul style="list-style-type: none"> <li>• Press <b>TRANS/PGM</b> button and dial <b>4 4</b> (<i>Aria-300/130: 3 1</i>).</li> <li>• Dial your own 5 digits access authorization code.</li> <li>• Press <b>HOLD/SAVE</b> button.</li> <li>• Confirmation tone is heard.</li> </ul>	
<p><i>Or using display, (Only in KD-33LD, KD/E-36LD, LKD-30LD)</i></p> <ul style="list-style-type: none"> <li>• Press the 5th menu key from the main menu.</li> </ul> <div style="display: flex; justify-content: space-around; align-items: center;"> <div style="border: 1px solid black; padding: 5px; width: 30%;"> <ul style="list-style-type: none"> <li>▪ INTERCOM CALL</li> <li>▪ STATION SPD DIAL</li> <li>▪ SYSTEM SPD DIAL</li> <li>▪ FEATURE</li> <li>▪ PROGRAM</li> <li>.....</li> <li>▪ STA 102 (T)</li> <li>▪ NOV 02 01:40pm</li> </ul> </div> <div style="font-size: 2em;">▶</div> <div style="border: 1px solid black; padding: 5px; width: 30%;"> <ul style="list-style-type: none"> <li>▪ ATD PROGRAM</li> <li>▪ STATION PROGRAM</li> <li>▪ LCD BRIGHTNESS</li> <li>▪ RING VOLUME</li> <li>▪ SPEAKER VOLUME</li> <li>.....</li> <li>▪ STA 102 (T)</li> <li>▪ NOV 02 01:40pm</li> </ul> </div> </div> <ul style="list-style-type: none"> <li>• Select the STATION PROGRAM and you will see the following.</li> </ul> <div style="border: 1px solid black; padding: 5px; width: 30%;"> <ul style="list-style-type: none"> <li>▪ S&gt;WAKE-UP SET</li> <li>▪ S&gt;WAKE-UP ERASE</li> <li>▪ S&gt;REG PASSWORD</li> <li>▪ S&gt;CHG PASSWORD</li> <li>▪ S&gt;INTERCOM ONLY</li> <li>.....</li> <li>▪ STA 102 (T)</li> <li>▪ NOV 02 01:40pm</li> </ul> </div>		

**Access Authorization Code ( \* ) (Cont'd)**

Button	Procedures	Range
--------	------------	-------

*In Aria-300/130, (Only in KD-33LD, KD/E-36LD, LKD-30LD)*

- Press the 5th menu key from the main menu.
 

<ul style="list-style-type: none"> <li>■ INTERCOM CALL</li> <li>■ STATION SPD DIAL</li> <li>■ SYSTEM SPD DIAL</li> <li>■ FEATURE</li> <li>■ PROGRAM</li> </ul> <hr style="border-top: 1px dashed black;"/> <div style="text-align: center;">                     STA 102 (T)                      NOV 02 01:40pm                 </div>	▶	<ul style="list-style-type: none"> <li>■ ATD PROGRAM</li> <li>■ STATION PROGRAM</li> <li>■ LCD BRIGHTNESS</li> <li>■ RING VOLUME</li> <li>■ SPEAKER VOLUME</li> </ul> <hr style="border-top: 1px dashed black;"/> <div style="text-align: center;">                     STA 102 (T)                      NOV 02 01:40pm                 </div>
---	---	--
- Select the STATION PROGRAM and press **PAGE** down(▼) key, you will see the following.
 

<ul style="list-style-type: none"> <li>■ S&gt;AUTHO REGISTER</li> <li>■ S&gt;AUTHO CHANGE</li> <li>■ S&gt;SET WAKEUP TM</li> <li>■ S&gt;WAKEUP DISBL</li> <li>■ S&gt;SET PRESEL MSG</li> </ul> <hr style="border-top: 1px dashed black;"/> <div style="text-align: center;">                     STA 102 (T)                      NOV 02 01:40pm                 </div>
---
- Select the AUTHO REGISTER and enter the 5 digits access authorization code.
- Press **HOLD/SAVE** button.



- To change access authorization code,*
- Press **TRANS/PGM** button and dial **4 5** (*Aria-300/130: 3 2*).
  - Dial your current access authorization code. You will hear confirmation tone.
  - Dial your new 5 digits access authorization code.
  - Press **HOLD/SAVE** button.
  - You will hear confirmation tone.

*Or using display, (Only in KD-33LD, KD/E-36LD, LKD-30LD)*

- Press the 5th menu key from the main menu.
- Select the STATION PROGRAM.
- Select the CHANGE PASSWORD and enter your current access authorization code.
- Enter your new 5 digits access authorization code.
- Press **HOLD/SAVE** button.



*In Aria-300/130, (Only in KD-33LD, KD/E-36LD, LKD-30LD)*



- Press the 5th menu key from the main menu.
- Select the STATION PROGRAM and press **PAGE** down(▼) key.
- Select the AUTHO CHANGE and enter your current access authorization code.
- Enter your new 5 digits access authorization code.
- Press **HOLD/SAVE** button.







## Blocking Outside Calls ( \* )

Note : An access authorization code should be registered.



Button	Procedures	Range				
 	<ul style="list-style-type: none"> <li>Press <b>TRANS/PGM</b> button and dial <b>4 6</b> (<i>Aria-300/130: 2 1</i>).</li> <li>Press <b>HOLD/SAVE</b> button. (Confirmation tone is heard.)</li> <li><b>MUTE</b> button will flash until restored to normal.</li> </ul> <p><i>Or using display, (Only in KD-33LD, KD/E-36LD, LKD-30LD)</i></p>					
	<ul style="list-style-type: none"> <li>Press the 5th menu key from the main menu.</li> <li>Press STATION PROGRAM key and you will see the following.                             <table border="1" data-bbox="446 683 1045 907"> <tr> <td> <ul style="list-style-type: none"> <li>S&gt;WAKE-UP SET</li> <li>S&gt;WAKE-UP ERASE</li> <li>S&gt;REG PASSWORD</li> <li>S&gt;CHG PASSWORD</li> <li>S&gt;INTERCOM ONLY</li> </ul> </td> <td> <ul style="list-style-type: none"> <li>S&gt;RING TYPE</li> <li>S&gt;ANSWER MODE</li> <li>S&gt;TMPRL COS DOWN</li> <li>S&gt;RESTORE COS</li> <li>S&gt;WALKING COS</li> </ul> </td> </tr> <tr> <td>                     STA 102 (T)                      NOV 02 01:40pm                 </td> <td>                     STA 102 (T)                      NOV 02 01:40pm                 </td> </tr> </table> <p style="text-align: center;">&lt; Aria-300/130 &gt;</p> </li> <li>Select INTERCOM ONLY. In Aria-300/130, select TMPRL COS DOWN.</li> <li>Press <b>HOLD/SAVE</b> button. (Confirmation tone is heard.)</li> <li><b>MUTE</b> button will flash until restored to normal.</li> </ul>	<ul style="list-style-type: none"> <li>S&gt;WAKE-UP SET</li> <li>S&gt;WAKE-UP ERASE</li> <li>S&gt;REG PASSWORD</li> <li>S&gt;CHG PASSWORD</li> <li>S&gt;INTERCOM ONLY</li> </ul>	<ul style="list-style-type: none"> <li>S&gt;RING TYPE</li> <li>S&gt;ANSWER MODE</li> <li>S&gt;TMPRL COS DOWN</li> <li>S&gt;RESTORE COS</li> <li>S&gt;WALKING COS</li> </ul>	STA 102 (T) NOV 02 01:40pm	STA 102 (T) NOV 02 01:40pm	
<ul style="list-style-type: none"> <li>S&gt;WAKE-UP SET</li> <li>S&gt;WAKE-UP ERASE</li> <li>S&gt;REG PASSWORD</li> <li>S&gt;CHG PASSWORD</li> <li>S&gt;INTERCOM ONLY</li> </ul>	<ul style="list-style-type: none"> <li>S&gt;RING TYPE</li> <li>S&gt;ANSWER MODE</li> <li>S&gt;TMPRL COS DOWN</li> <li>S&gt;RESTORE COS</li> <li>S&gt;WALKING COS</li> </ul>					
STA 102 (T) NOV 02 01:40pm	STA 102 (T) NOV 02 01:40pm					

## Restoring Outside Calls ( \* )

Button	Procedures	Range				
	<ul style="list-style-type: none"> <li>Press <b>TRANS/PGM</b> button and dial <b>4 7</b> (<i>Aria-300/130: 2 2</i>).</li> <li>Dial your current access authorization code. (Confirmation tone is heard.)</li> <li><b>MUTE</b> button will be extinguished.</li> </ul> <p><i>Or using display, (Only in KD-33LD, KD/E-36LD, LKD-30LD)</i></p>					
  	<ul style="list-style-type: none"> <li>Press the 5th menu key from the main menu.</li> <li>Press STATION PROGRAM key.</li> <li>Press <b>PAGE</b> down(▼) key.</li> <li>On the display, you will see the following.                             <table border="1" data-bbox="446 1668 1045 1892"> <tr> <td> <ul style="list-style-type: none"> <li>S&gt;RESTORE COS</li> <li>S&gt;MSG PROGRAM</li> <li>S&gt;ICM ANS MODE</li> <li>S&gt;MUSIC CHANNEL</li> <li>S&gt;PRESELECT MSG</li> </ul> </td> <td> <ul style="list-style-type: none"> <li>S&gt;RING TYPE</li> <li>S&gt;ANSWER MODE</li> <li>S&gt;COS DOWN</li> <li>S&gt;RESTORE COS</li> <li>S&gt;WALKING COS</li> </ul> </td> </tr> <tr> <td>                     STA 102 (T)                      NOV 02 01:40pm                 </td> <td>                     STA 102 (T)                      NOV 02 01:40pm                 </td> </tr> </table> <p style="text-align: center;">&lt; Aria-300/130 &gt;</p> </li> <li>Select RESTORE COS key.</li> <li>Enter your current access authorization code.</li> <li>Press <b>HOLD/SAVE</b> button.</li> </ul>	<ul style="list-style-type: none"> <li>S&gt;RESTORE COS</li> <li>S&gt;MSG PROGRAM</li> <li>S&gt;ICM ANS MODE</li> <li>S&gt;MUSIC CHANNEL</li> <li>S&gt;PRESELECT MSG</li> </ul>	<ul style="list-style-type: none"> <li>S&gt;RING TYPE</li> <li>S&gt;ANSWER MODE</li> <li>S&gt;COS DOWN</li> <li>S&gt;RESTORE COS</li> <li>S&gt;WALKING COS</li> </ul>	STA 102 (T) NOV 02 01:40pm	STA 102 (T) NOV 02 01:40pm	
<ul style="list-style-type: none"> <li>S&gt;RESTORE COS</li> <li>S&gt;MSG PROGRAM</li> <li>S&gt;ICM ANS MODE</li> <li>S&gt;MUSIC CHANNEL</li> <li>S&gt;PRESELECT MSG</li> </ul>	<ul style="list-style-type: none"> <li>S&gt;RING TYPE</li> <li>S&gt;ANSWER MODE</li> <li>S&gt;COS DOWN</li> <li>S&gt;RESTORE COS</li> <li>S&gt;WALKING COS</li> </ul>					
STA 102 (T) NOV 02 01:40pm	STA 102 (T) NOV 02 01:40pm					

## Wake-up Call

The system automatically sends ring signal to a station which registers a wake-up time. There are two kinds of wake-up call, one is effective for one-day, the other is effective until canceled.

Button	Procedures	Range
 	<p><i>To register wake-up time,</i></p> <ul style="list-style-type: none"> <li>• Press <b>TRANS/PGM</b> button.</li> <li>• Dial <b>4 1</b> and 4-digit wake-up time (HHMM) in 24-hour mode. (HH = 00~23, MM = 00~59)</li> <li>• Press <b>HOLD/SAVE</b> button for “one-day” or dial # and <b>HOLD/SAVE</b> button for “until canceled”. (Confirmation tone is heard.)</li> </ul>	

Or using display, **(Only in KD-33LD, KD/E-36LD, LKD-30LD)**

- Press the 5th menu key from the main menu.
 

- ATD PROGRAM
  - STATION PROGRAM
  - LCD BRIGHTNESS
  - RING VOLUME
  - SPEAKER VOLUME
  - .....
  - STA 102 (T)     ▲
  - ▣ NOV 02 01:40pm     ▼
- Select the STATION PROGRAM and you will see the following.
 

- S>WAKE-UP SET
  - S>WAKE-UP ERASE
  - S>REG PASSWORD
  - S>CHG PASSWORD
  - S>INTERCOM ONLY
  - .....
  - STA 102 (T)     ▲
  - ▣ NOV 02 01:40pm     ▼
- Select WAKE-UP SET key.

In Aria-300/130, **(Only in KD-33LD, KD/E-36LD, LKD-30LD)**

- Press the 5th menu key from the main menu.
 



- INTERCOM CALL
  - STATION SPD DIAL
  - SYSTEM SPD DIAL
  - FEATURE
  - PROGRAM
  - .....
  - STA 102 (T)     ▲
  - ▣ NOV 02 01:40pm     ▼

▶

- ATD PROGRAM
  - STATION PROGRAM
  - LCD BRIGHTNESS
  - RING VOLUME
  - SPEAKER VOLUME
  - .....
  - STA 102 (T)     ▲
  - ▣ NOV 02 01:40pm     ▼
- Select the STATION PROGRAM and press **PAGE** down(▼) key, you will see the following.
 

- S>AUTHO REGISTER
  - S>AUTHO CHANGE
  - S>SET WAKEUP TM
  - S>WAKEUP DISBL
  - S>SET PRESEL MSG
  - .....
  - STA 102 (T)     ▲
  - ▣ NOV 02 01:40pm     ▼
- Select SET WAKEUP TM key.

## Wake-up Call (Cont'd)

Button	Procedures	Range
 HOLD/SAVE	<ul style="list-style-type: none"> <li>• Enter 4-digit wake-up time (HHMM) in 24-hour mode. (HH = 00~23, MM = 00~59)</li> <li>• Press <b>HOLD/SAVE</b> button for “one-day” or dial # and <b>HOLD/SAVE</b> button for “until canceled”. (Confirmation tone is heard.)</li> </ul>	
 TRANS/PGM	<p><i>To cancel wake-up call,</i></p> <ul style="list-style-type: none"> <li>• Press <b>TRANS/PGM</b> button and dial <b>4 2</b>.</li> <li>• Press <b>HOLD/SAVE</b> button. (Confirmation tone is heard.)</li> </ul>	
 HOLD/SAVE	<p><i>Or using display, (Only in KD-33LD, KD/E-36LD, LKD-30LD)</i></p> <ul style="list-style-type: none"> <li>• Press the 5th menu key from the main menu.</li> <li>• Select STATION PROGRAM key.</li> <li>• Select WAKE-UP ERASE key.</li> <li>• Press <b>HOLD/SAVE</b> button. (Confirmation tone is heard.)</li> </ul>	
	<p><i>In Aria-300/130, (Only in KD-33LD, KD/E-36LD, LKD-30LD)</i></p> <ul style="list-style-type: none"> <li>• Press the 5th menu key from the main menu.</li> <li>• Select STATION PROGRAM key and press <b>PAGE</b> down(▼) key.</li> <li>• Select WAKE-UP DISBL key.</li> <li>• Press <b>HOLD/SAVE</b> button. (Confirmation tone is heard.)</li> </ul>	





## Using Dial By Name

Each station and speed dial number can be assigned to a name. When names are programmed, you may select a speed dial number by the stored name.

Button	Procedures	Range
 SPEED	<ul style="list-style-type: none"> <li>• Press <b>SPEED</b> button twice.</li> <li>• On the display, you will see the following.                         <div data-bbox="411 1592 794 1675" style="border: 1px solid black; padding: 5px; margin: 10px 0;">                             DIAL BY NAME                              ICM : 1 U_SPD : 2 S_SPD : 3                         </div> </li> <li>• Select desired type.                         <ul style="list-style-type: none"> <li>1 : Intercom</li> <li>2 : User (Station Speed Dial)</li> <li>3 : System (System Speed Dial)</li> </ul> </li> <li>• Confirmation tone is heard and you will see the following.                         <div data-bbox="411 1883 794 1966" style="border: 1px solid black; padding: 5px; margin: 10px 0;">                             1 : XXXX XXXX XXXXXX                              2 : YYYY YYYY YYYYYY                         </div> </li> </ul>	

## Using Dial By Name (Cont'd)

Each station and speed dial number can be assigned to a name. When names are programmed, you may select a speed dial number by the stored name.

Button	Procedures	Range
  	<ul style="list-style-type: none"> <li>• Press the <b>VOLUME</b> button to see the next two names.</li> <li>• You may enter characters using the code in “Storing Dial by Name”. The LCD will display the first two names which match your input.</li> <li>• To select the name in line 1, press <b>HOLD/SAVE</b> button.</li> <li>• To select the name in line 2, dial 2 and press <b>HOLD/SAVE</b> button.</li> <li>• The call is placed automatically.</li> </ul>	
<p><i>In Aria-300/130, Aria16/20W</i></p>		
	<ul style="list-style-type: none"> <li>• Press <b>SPEED</b> button twice.</li> <li>• On the display, you will see the following.</li> </ul> <div data-bbox="411 898 794 976" style="border: 1px solid black; padding: 5px; margin: 10px 0;"> <p style="text-align: center;">DIAL BY NAME ICM : 1 U_SPD : 2 S_SPD : 3</p> </div> <ul style="list-style-type: none"> <li>• Select desired type.                             <ul style="list-style-type: none"> <li>1 : Intercom</li> <li>2 : User (Station Speed Dial)</li> <li>3 : System (System Speed Dial)</li> </ul> </li> <li>• Confirmation tone is heard and you will see the following.</li> </ul> <div data-bbox="411 1189 794 1267" style="border: 1px solid black; padding: 5px; margin: 10px 0;"> <p style="text-align: center;">1 : XXXX XXXX XXXXXX 2 : YYYY YYYY YYYYYY</p> </div>	
  	<ul style="list-style-type: none"> <li>• Pressing <b>VOLUME</b> button, the cursor will be moved to the next name. When the cursor points a name or a dial number to call, press <b>HOLD/SAVE</b> button. Then, the stored number is dialed.</li> <li>• You may enter characters using the code in “Storing Dial by Name”. The LCD will display the first two names which match your input. (You may delete the last letter of your input by pressing <b>CALLBK</b> button. And then, the previous matched name is displayed.)</li> <li>• You can see the matched phone number by pressing <b>FLASH</b> button while the name is displayed (toggle).</li> </ul>	

**Using Dial By Name ( \* ) (Cont'd)**

Button	Procedures	Range
--------	------------	-------

Or using display, (Only in KD-33LD, KD/E-36LD, LKD-30LD)

**Intercom Call**

(Intercom name should be programmed by attendant.)

- Press the 1st menu key from the main menu.  
If it is programmed, you will see the following on the display.

▪ AB	LMN	▪
▪ CD	OPQ	▪
▪ EFG	RST	▪
▪ HI	UVW	▪
▪ JK	XYZ	▪
.....		
STA 102 (T)		
▪	NOV 02 01:40pm	▾

- Select the key according to the first letter of the desired party's name. (Ex. Selecting the first letter with HI, you will see the sorted subscriber's name as follows.)

▪ HONG H.S.	▪
▪ JANG W.H.	▪
▪ KIM Y.J.	▪
▪ LEE M.S.	▪
▪ LEE S.H.	▪
.....	
STA 102 (T)	
▪	NOV 02 01:40pm

- Press **PAGE** (▲/▼) button until you find the desired name.

▪ LEE Y.U.	▪
▪	▪
▪	▪
▪	▪
▪	▪
.....	
STA 102 (T)	
▪	NOV 02 01:40pm

**Station Speed Dial**

(Station Speed Dial should be programmed at a station.)

- Press the 2nd menu key from the main menu.  
You will see the following on the display.

▪ AB	LMN	▪
▪ CD	OPQ	▪
▪ EFG	RST	▪
▪ HI	UVW	▪
▪ JK	XYZ	▪
.....		
STA 102 (T)		
▪	NOV 02 01:40pm	▾

- Follow the procedure as described in *Intercom Call*.

**System Speed Dial**



(System Speed Dial should be programmed by attendant.)

- Press the 3rd menu key from the main menu.  
• Follow the procedure as described in *Station Speed Dial*.





## Programming Your Name into Display

You can program your name and people using display phones will see your name instead of your station number.

Button	Procedures	Range
  	<ul style="list-style-type: none"> <li>• Press <b>TRANS/PGM</b> button.</li> <li>• Press <b>SPEED</b> button and dial <b>0 0</b>.</li> <li>• Press <b>SPEED</b> button.</li> <li>• Enter your name. (up to 7 letters using the code in “Storing Dial by name.”)</li> <li>• Press <b>HOLD/SAVE</b> button.</li> </ul>	16: Above V4.0 20W: Above V3.0)
<p><i>In Aria-300/130</i></p>	<ul style="list-style-type: none"> <li>• Press <b>TRANS/PGM</b> button.</li> <li>• Dial <b>7 4</b>.</li> <li>• Enter your name. (up to 7 letters using the code in “Storing Dial by name.”)</li> <li>• Press <b>HOLD/SAVE</b> button.</li> </ul>	

## Pre-selected Message ( \* )

You can select a pre-assigned message to be displayed on the LCD of the phone calling the station.

Button	Procedures	Range
 	<ul style="list-style-type: none"> <li>• Press <b>TRANS/PGM</b> button and dial <b>7 7</b> (<i>Aria-300/130: 5 1</i>).</li> <li>• Dial the number of desired message. Date, Time or Station Number if required.</li> <li>• Press <b>HOLD/SAVE</b> button. (<b>DND/FWD</b> button is flashing.)</li> </ul> <div style="background-color: #f0f0f0; padding: 5px; margin-top: 5px;">                     0 1 LUNCH, RETURN HH:MM                      0 2 ON VACATION / RETURN AT MM:DD                      0 3 OUT OF OFFICE/ RERURN TIME HH:MM                      0 4 OUT OF OFFICE/ RETURN AT MM:DD                      0 5 OUT OF OFFICE/ RETURN UNKNOWN                      0 6 CALL : XX... (Telephone number: Max. 17 digits)                      0 7 IN OFFICE/STA XXXX                      0 8 IN A MEETING / RETURN TIME (HH:MM)                      0 9 AT HOME                      1 0 AT BRANCH OFFICE                      # to cancel                      1 1 ~ 2 0 are used for customized messages which are programmed by attendant. (See “Creating Customized Message”)                 </div>	
<p><i>Or using display, (Only in KD-33LD, KD/E-36LD, LKD-30LD)</i></p>	<ul style="list-style-type: none"> <li>• Press the 5th menu key from main menu and you will see the following on the display.</li> </ul> <div style="border: 1px solid black; padding: 5px; margin-top: 5px; width: fit-content;"> <ul style="list-style-type: none"> <li>▪ ATD PROGRAM</li> <li>▪ STATION PROGRAM</li> <li>▪ LCD BRIGHTNESS</li> <li>▪ RING VOLUME</li> <li>▪ SPEAKER VOLUME</li> <li>.....</li> <li>▪ STA 102 (T)</li> <li>▪ NOV 02 01:40pm</li> </ul> </div>	

**Pre-selected Message ( \* ) (Cont'd)**

You can select a pre-assigned message to be displayed on the LCD of the phone calling the station.

Button	Procedures	Range
--------	------------	-------



- Select STATION PROGRAM key.  
On the display, you will see the following.

```

■ S>WAKE-UP SET ■
■ S>WAKE-UP ERASE ■
■ S>REG PASSWORD ■
■ S>CHG PASSWORD ■
■ S>INTERCOM ONLY ■
.....
STA 102 (T) ▲
NOV 02 01:40pm ▼
    
```

- Press **PAGE** down(▼) key and you will see the following on the display.

```

■ S>RESTORE COS ■
■ S>MSG PROGRAM ■
■ S>ICM INS MODE ■
■ S>MUSIC CHANNEL ■
■ S>PRESELECT MSG ■
.....
STA 102 (T) ▲
NOV 02 01:40pm ▼
    
```

- Select PRESELECT MSG.  
• On the display, you will see the following.

```

■ LUNCH (TIME) ■
■ VACATION (DATE) ■
■ OUT (TIME) ■
■ OUT (DATE) ■
■ OUT ( ? ) ■
.....
STA 102 (T) ▲
NOV 02 01:40pm ▼
    
```

- Select desired message key, date, time or station number, if required.
- Press **HOLD/SAVE** button. (DND/FWD button is flashing.)





*In Aria-300/130, (Only in KD-33LD, KD/E-36LD, LKD-30LD)*

- Press the 5th menu key from main menu and you will see the following on the display.

```



■ ATD PROGRAM ■
■ STATION PROGRAM ■
■ LCD BRIGHTNESS ■
■ RING VOLUME ■
■ SPEAKER VOLUME ■
.....
STA 102 (T) ▲
NOV 02 01:40pm ▼
    
```

**Pre-selected Message (Cont'd)**

Button	Procedures	Range
 	<ul style="list-style-type: none"> <li>Select the STATION PROGRAM and press <b>PAGE</b> down(▼) key, you will see the following.                             <div style="border: 1px solid black; padding: 5px; margin: 10px 0;"> <ul style="list-style-type: none"> <li>▪ S&gt;AUTHO REGISTER   ▪</li> <li>▪ S&gt;AUTHO CHANGE   ▪</li> <li>▪ S&gt;SET WAKEUP TM   ▪</li> <li>▪ S&gt;WAKEUP DISBL   ▪</li> <li>▪ S&gt;SET PRESEL MSG   ▪</li> </ul> <hr style="border-top: 1px dashed black;"/> <p style="text-align: center;">STA 102 (T)   ▲</p> <p style="text-align: center;">NOV 02 01:40pm   ▼</p> </div> </li> <li>Select SET PRESEL MSG.</li> <li>On the display, you will see the following.                             <div style="display: flex; justify-content: space-around; margin: 10px 0;"> <div style="border: 1px solid black; padding: 5px;"> <ul style="list-style-type: none"> <li>▪ LUNCH (TIME)   ▪</li> <li>▪ VACATION (DATE)   ▪</li> <li>▪ OUT (TIME)   ▪</li> <li>▪ OUT (DATE)   ▪</li> <li>▪ OUT ( ? )   ▪</li> </ul> <hr style="border-top: 1px dashed black;"/> <p style="text-align: center;">STA 102 (T)   ▲</p> <p style="text-align: center;">NOV 02 01:40pm   ▼</p> </div> <div style="border: 1px solid black; padding: 5px;"> <ul style="list-style-type: none"> <li>▪ CALL XXXX (TEL)   ▪</li> <li>▪ STA XXXX (STA#)   ▪</li> <li>▪ MEETING (TIME)   ▪</li> <li>▪ AT HOME   ▪</li> <li>▪ AT BRANCH OFFICE   ▪</li> </ul> <hr style="border-top: 1px dashed black;"/> <p style="text-align: center;">STA 102 (T)   ▲</p> <p style="text-align: center;">NOV 02 01:40pm   ▼</p> </div> </div> </li> <li>Select desired message key, date, time or station number, if required.</li> <li>Press <b>HOLD/SAVE</b> button. (DND/FWD button is flashing.)</li> </ul> <p><i>To turn off message display,</i></p> <ul style="list-style-type: none"> <li>Press flashing <b>DND/FWD</b> button.</li> </ul>	

**User Custom Message Programming ( \* )**

You may program a custom message 00 to be displayed on the LCD of the phone calling your station.

Button	Procedures	Range
  	<ul style="list-style-type: none"> <li>Press <b>TRANS/PGM</b> button and dial <b>4 8</b> (<i>Aria-300/130: 5 2</i>) at the station. (Confirmation tone is heard.)</li> <li>Enter the message. (up to 24 letters using the code in “Storing Dial by Name”)</li> <li>Press <b>HOLD/SAVE</b> button.</li> </ul>	





## Background Music

A station can receive audio, generally music from an internal or external source while idle.





Button	Procedures	Range
	<ul style="list-style-type: none"> <li>• Press <b>TRANS/PGM</b> button.</li> <li>• Dial <b>7 3</b> .</li> <li>• Internal BGM is heard.</li> <li>• Pressing TRANS/PGM + 7 3, the selected music is changed by turns. (Channel 0 (00): BGM is not heard.)</li> </ul>	Aria-300:00~12 Aria-130:00~11 186 : 0~9 100 : 0~9 34e : 0~9 16/20W : 1~3
<p><i>In Aria-300/130,</i></p>	<ul style="list-style-type: none"> <li>• Press <b>TRANS/PGM</b> button.</li> <li>• Dial <b>7 3</b> and select BGM channel (00~12).</li> <li>• Press <b>HOLD/SAVE</b> button.</li> </ul>	

## Voice Announcement

This feature provides the station an audible system prompt and you can record your greeting to provide the caller when the call is not answered within the predefined time.

Button	Procedures	Range										
 	<p><i>Time Prompt :</i></p> <ul style="list-style-type: none"> <li>• Dial <b>4 0 1</b>.</li> <li>• You will hear the time prompt, "Time is XX : XX PM."</li> </ul> <p><i>Date Prompt :</i></p> <ul style="list-style-type: none"> <li>• Dial <b>4 0 2</b>.</li> <li>• You will hear the date prompt, "Date is December, 20th."</li> </ul> <p><i>Station Number Prompt :</i></p> <ul style="list-style-type: none"> <li>• Dial <b>4 0 3</b>.</li> <li>• You will hear the station number prompt, "This is station XXXX."</li> </ul> <p><i>Record your greeting,</i></p> <ul style="list-style-type: none"> <li>• Dial <b>4 0 4</b> (The message is heard after 4sec) or <b>4 0 0</b> (The message is heard after predefined time) .</li> <li>• To stop recording, press <b>MON</b> button or <b>HOLD/SAVE</b> button. ( <b>MON</b> button: erased automatically after 48 hours, <b>HOLD/SAVE</b> button: remained until canceled)</li> <li>• After recording your greeting message, a caller will hear your greeting message when you do not answer the call within a predefined time (PGM 43-BTN 24).</li> </ul> <p><i>Delete your greeting,</i></p> <ul style="list-style-type: none"> <li>• Dial <b>4 0 5</b>.</li> </ul> <p><i>Playback your greeting,</i></p> <ul style="list-style-type: none"> <li>• Dial <b>4 0 *</b>. (You will hear the recorded greeting message.)</li> </ul> <p><i>Station status prompt ;</i></p> <ul style="list-style-type: none"> <li>• Dial <b>4 0 7</b>. (You will hear below list (a-h). c-g items will be omitted if not active.)</li> </ul> <table style="width: 100%; border: none;"> <tr> <td style="width: 50%;">a) Station number XXXX</td> <td style="width: 50%;">b) Intercom Answer mode</td> </tr> <tr> <td>c) Listed message X</td> <td>d) Wake-up time XXXX AM or PM</td> </tr> <tr> <td>e) Do not disturb</td> <td>f) Forwarded to station XXXX</td> </tr> <tr> <td>g) Forwarded to speed bin XXX</td> <td>h) Locked (temporary COS change)</td> </tr> <tr> <td>i) COS X</td> <td></td> </tr> </table>	a) Station number XXXX	b) Intercom Answer mode	c) Listed message X	d) Wake-up time XXXX AM or PM	e) Do not disturb	f) Forwarded to station XXXX	g) Forwarded to speed bin XXX	h) Locked (temporary COS change)	i) COS X		
a) Station number XXXX	b) Intercom Answer mode											
c) Listed message X	d) Wake-up time XXXX AM or PM											
e) Do not disturb	f) Forwarded to station XXXX											
g) Forwarded to speed bin XXX	h) Locked (temporary COS change)											
i) COS X												





**Voice Announcement** (Cont'd)

Button	Procedures	Range
	<p><i>Record paging message;</i></p> <ul style="list-style-type: none"> <li>• Dial <b>4 0 8</b>.</li> <li>• Lift handset to record your paging message.</li> <li>• Press <b>HOLD/SAVE</b> button after recording.</li> </ul> <p><i>Confirm paging message;</i></p> <ul style="list-style-type: none"> <li>• Dial <b>4 0 9</b>.</li> <li>• The paging message is heard.</li> </ul>	
	<p><i>Activate Call Forward to DVU,</i></p> <ul style="list-style-type: none"> <li>• Lift handset or press <b>MON</b> button.</li> <li>• Press <b>DND/FWD</b> button.</li> <li>• Dial <b>7</b> or <b>8</b> or <b>9</b> (Select DVU forward type 1 or 2).</li> <li>• Go on-hook. (<b>8</b> = No Answer, <b>9</b> = Busy.)</li> </ul> <p><i>Deactivate Call Forward to DVU,</i></p> <ul style="list-style-type: none"> <li>• Lift handset or press <b>MON</b> button.</li> <li>• Press <b>DND/FWD</b> button.</li> <li>• Dial <b>#</b>.</li> <li>• Go on-hook.</li> </ul>	
	<p><i>Listen to the recorded message,</i></p> <ul style="list-style-type: none"> <li>• Press the flashing <b>CALLBK</b> button.</li> <li>• The recorded message is heard with the time and date.</li> </ul>	
	<ul style="list-style-type: none"> <li>• Pressing <b>HOLD/SAVE</b> button, the current message is saved and the next message is heard.</li> </ul>	
	<ul style="list-style-type: none"> <li>• Pressing <b>CALLBK</b> button, the recorded message is heard from the first.</li> <li>• Pressing <b>CONF</b> button, the current message is deleted.</li> </ul>	
	<ul style="list-style-type: none"> <li>※ The recorded caller's message will not be erased without pressing CONF button. But, the system power is off or system is reset, it will be erased.</li> <li>※ The max. user recording time is about 250sec. (Default: 20sec: it can be programmable with admin programming - PGM 44-BTN 16.)</li> </ul>	





On LKD-2N/S, 8D/S,

	<ul style="list-style-type: none"> <li>• If a DVU message is left, the MSG lamp is flashing.</li> <li>• Dial <b>5 7</b> or programmed <b>CALLBK</b> button to listen to the recorded message.</li> <li>• The recorded message is heard and then the message is automatically deleted.</li> <li>• Pressing <b>HOLD/SAVE</b> button while a message is played, the next message is heard. (The current message is placed to the last.)</li> <li>• Pressing programmed <b>CALLBK</b> button, the recorded message is heard from the first.</li> <li>• If you don't press <b>HOLD/SAVE</b> button any more, the current message is deleted and other messages are remained.</li> <li>• If you program a flex. button as a <b>CONF</b> button, the message will be saved and you should press the programmed <b>CONF</b> button to delete the message (only in Aria-16).</li> </ul>	
---	--	--



**Voice Announcement (Cont'd)**

Button	Procedures	Range
<i>Or using display, (Only in KD-33LD, KD/E-36LD, LKD-30LD)</i>		
	<p><i>Time Prompt;</i></p> <ul style="list-style-type: none"> <li>• Dial <b>4 0 1</b>.</li> <li>• You will hear the time prompt, "Time is XX : XX PM."</li> </ul> <p><i>Date Prompt :</i></p> <ul style="list-style-type: none"> <li>• Dial <b>4 0 2</b>.</li> <li>• You will hear the date prompt, "Date is December, 20th."</li> </ul> <p><i>Station Number Prompt :</i></p> <ul style="list-style-type: none"> <li>• Dial <b>4 0 3</b>.</li> <li>• You will hear the station number prompt, "This is station XXXX."</li> </ul> <p><i>Record paging message;</i></p> <ul style="list-style-type: none"> <li>• Dial <b>4 0 8</b>.</li> <li>• Lift handset to record your paging message.</li> <li>• Press <b>HOLD/SAVE</b> button after recording.</li> </ul>	
	<p><i>DVU station status;</i></p> <ul style="list-style-type: none"> <li>• Press the 4th key from the main menu.</li> <li>• Press <b>PAGE</b> down(▼) key 4 times.</li> <li>• Select DVU STA STATUS.</li> <li>• You will hear below lists (a - I).</li> <li>a) Station number XXXX</li> <li>b) Ring assignment</li> <li>c) Listed message X</li> <li>d) Wake-up time XXXX AM or PM</li> <li>e) Do Not disturb</li> <li>f) Forwarded to station XXXX</li> <li>g) Forwarded to speed bin XXX</li> <li>h) Locked (temporary COS change)</li> <li>i) COS X</li> </ul>	
	<p><i>Record your greeting;</i></p> <ul style="list-style-type: none"> <li>• Press the 4th key from the main menu.</li> <li>• Press <b>PAGE</b> down(▼) key 3 times.</li> <li>• Select DVU RECORD key.</li> <li>• Lift handset to record your greeting message.</li> <li>• Press <b>HOLD/SAVE</b> button.</li> </ul>	
	<p><i>Delete your recording;</i></p> <ul style="list-style-type: none"> <li>• Press the 4th key from the main menu.</li> <li>• Press <b>PAGE</b> down(▼) key 3 times.</li> <li>• Select DVU DELETE key.</li> </ul>	
	<p><i>Playback your greeting ;</i></p> <ul style="list-style-type: none"> <li>• Press the 4th key from the main menu.</li> <li>• Press <b>PAGE</b> down(▼) key 3 times.</li> <li>• Select DVU PLAY key.</li> </ul>	
	<p><i>Paging your greeting ;</i></p> <ul style="list-style-type: none"> <li>• Lift handset and dial the desired page zone.</li> <li>• After hearing confirmation tone, your recorded paging message is sent to the page zone automatically.</li> </ul>	

**Voice Announcement (in Aria-16/20W) (Cont'd)**

Button	Procedures	Range
<i>In Aria-16/20W,</i>		
	<p><i>Record your greeting,</i></p> <ul style="list-style-type: none"> <li>• Lift handset or press <b>MON</b> button.</li> <li>• Press <b>DND/FWD</b> button.</li> <li>• Dial <b>7 #</b>.</li> </ul> <p><i>Delete your greeting,</i></p> <ul style="list-style-type: none"> <li>• Lift handset or press <b>MON</b> button.</li> <li>• Press <b>DND/FWD</b> button.</li> <li>• Dial <b>7 *</b>.</li> </ul> <p><i>Activate Call Forward to DVU,</i></p> <ul style="list-style-type: none"> <li>• Lift handset or press <b>MON</b> button.</li> <li>• Press <b>DND/FWD</b> button.</li> <li>• Dial <b>7 .</b></li> <li>• Go on-hook.</li> </ul> <p><i>Deactivate Call Forward to DVU,</i></p> <ul style="list-style-type: none"> <li>• Lift handset or press <b>MON</b> button.</li> <li>• Press <b>DND/FWD</b> button.</li> <li>• Dial <b>#</b>.</li> <li>• Go on-hook.</li> </ul>	
  	<p><i>To listen to the recorded message,</i></p> <ul style="list-style-type: none"> <li>• Press the flashing <b>CALLBK</b> button.</li> <li>• The recorded message is heard with the time and date.</li> <li>• Pressing <b>HOLD/SAVE</b> button, the current message is saved and the next message is heard.</li> <li>• Pressing <b>CALLBK</b> button, the recorded message is heard from the first.</li> <li>• Pressing <b>CONF</b> button, the current message is deleted.</li> </ul> <p>* The operation of 2/8 BTN keyset is the same with other Aria systems. (Refer to p.36)</p> <p>※ The max. user recording time is about 250sec. (Default: 20sec: it can be programmable with admin programming - Main Menu 6-1-24)</p>	

**Voice Announcement (in Aria-300/130) (Cont'd)**

Button	Procedures	Range										
<p><i>In Aria-300/130,</i></p>	<p><i>Date &amp; Time Prompt ;</i></p> <ul style="list-style-type: none"> <li>• Press <b>TRANS/PGM</b> button and dial <b>6 2</b>.</li> <li>• You will hear the time prompt, "Date is December, 20th, Time is XX : XX PM."</li> </ul> <p><i>Station Number Prompt ;</i></p> <ul style="list-style-type: none"> <li>• Press <b>TRANS/PGM</b> button and dial <b>6 3</b>.</li> <li>• You will hear the station number prompt, "This is station XXXX."</li> </ul> <p><i>Station Status Prompt ;</i></p> <ul style="list-style-type: none"> <li>• Press <b>TRANS/PGM</b> button and dial <b>6 4</b>. (You will hear below list (a-j). c-i items will be omitted if not active.)                             <table border="0" data-bbox="389 813 1182 958"> <tr> <td>a) Station number XXXX</td> <td>b) Intercom Answer Mode</td> </tr> <tr> <td>c) Listed message X</td> <td>d) Wake-up time XX:XX AM or PM</td> </tr> <tr> <td>e) Do not disturb</td> <td>f) Forwarded to station XXXX</td> </tr> <tr> <td>g) Forwarded to speed bin XXX</td> <td>h) Queued CO XXX</td> </tr> <tr> <td>i) Locked (temporary COS change)</td> <td>j) COS X</td> </tr> </table> </li> </ul>	a) Station number XXXX	b) Intercom Answer Mode	c) Listed message X	d) Wake-up time XX:XX AM or PM	e) Do not disturb	f) Forwarded to station XXXX	g) Forwarded to speed bin XXX	h) Queued CO XXX	i) Locked (temporary COS change)	j) COS X	
	a) Station number XXXX	b) Intercom Answer Mode										
	c) Listed message X	d) Wake-up time XX:XX AM or PM										
	e) Do not disturb	f) Forwarded to station XXXX										
	g) Forwarded to speed bin XXX	h) Queued CO XXX										
	i) Locked (temporary COS change)	j) COS X										
	 <p>HOLD/SAVE</p>	<p><i>Record your greeting,</i></p> <ul style="list-style-type: none"> <li>• Press <b>TRANS/PGM</b> button and dial <b>6 1</b>.</li> <li>• "Press # button to record" is heard and if there is a recorded greeting, the greeting will be played.</li> <li>• Press <b>#</b> button and record your greeting after hearing confirmation tone.</li> <li>• Press <b>HOLD/SAVE</b> button or <b>MON</b> button to finish recording, then you will hear confirmation tone.</li> <li>• Pressing <b>SPEED</b> button while playing, the greeting is deleted and confirmation tone is heard.</li> </ul>										
		<p><i>Delete your greeting,</i></p> <ul style="list-style-type: none"> <li>• Press <b>TRANS/PGM</b> button and dial <b>6 6</b>.</li> </ul>										
		 <p>DND/FWD</p>	<p><i>Activate Call Forward to VMIB,</i></p> <ul style="list-style-type: none"> <li>• Lift handset or press <b>MON</b> button.</li> <li>• Press <b>DND/FWD</b> button.</li> <li>• Dial Call Forward type code (1~4).</li> <li>• Dial <b>#</b> key . (Confirmation tone is heard.)</li> <li>• Go on-hook.</li> </ul>									
	<p><i>Deactivate Call Forward to VMIB,</i></p> <ul style="list-style-type: none"> <li>• Lift handset or press <b>MON</b> button.</li> <li>• Press <b>DND/FWD</b> button.</li> </ul>											
<p><i>Leave voice message wait,</i></p> <ul style="list-style-type: none"> <li>• After user greeting is played. "Record your message" prompt is heard.</li> <li>• After beep tone, record your message with normal voice.</li> <li>• Hang up.</li> </ul>												

**Voice Announcement (in Aria-300/130) (Cont'd)**

Button	Procedures	Range
	<p><i>Listen to the recorded message,</i></p> <ul style="list-style-type: none"> <li>• Press the flashing <b>CALLBK</b> button.</li> <li>• The recorded message is heard with the time and date.</li> <li>• Pressing <b>HOLD/SAVE</b> button, the current message is saved and the next message is heard.</li> <li>• Pressing <b>CALLBK</b> button, the current message is played again.</li> <li>• Pressing <b>CONF</b> button, the current message is deleted and the next message is heard.</li> </ul> <p>* The operation of 2/8 BTN keyset is the same with other Aria systems.</p> <p><i>Record VMIB Paging Message,</i></p> <ul style="list-style-type: none"> <li>• Press <b>TRANS/PGM</b> button and dial <b>6 5</b>.</li> <li>• “Press # button to record” is heard and if there is a recorded paging message, it will be played.</li> <li>• Press # button and record paging message after hearing confirmation tone.</li> <li>• Press <b>HOLD/SAVE</b> button or <b>MON</b> button to finish recording, then you will hear confirmation tone.</li> <li>• Pressing <b>SPEED</b> button while playing, the greeting is deleted and confirmation tone is heard.</li> </ul> <p><i>Activate VMIB Message Paging,</i></p> <ul style="list-style-type: none"> <li>• Dial the desired page zone (<b>#XX</b>) and lift handset.</li> <li>• The recorded VMIB message is paged.</li> </ul> <p><i>Delete VMIB Paging Message,</i></p> <ul style="list-style-type: none"> <li>• Press <b>TRANS/PGM</b> button and dial <b>6 7</b>.</li> <li>• The recorded message is deleted.</li> <li>• Or, press <b>SPEED</b> button while playing, then the message is deleted and confirmation tone is heard.</li> </ul>	

*Or using display, (Only in KD-33LD, KD/E-36LD, LKD-30LD)*

- Press the 5th menu key from main menu and you will see the following on the display.

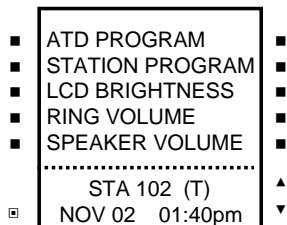





**Voice Announcement (in Aria-300/130) (Cont'd)**

Button	Procedures	Range
	<ul style="list-style-type: none"> <li>• Select the STATION PROGRAM and press <b>PAGE</b> down(▼) key twice, you will see the following.</li> </ul> <div style="border: 1px solid black; padding: 5px; margin: 10px 0;"> <pre> S&gt;SET CUSTOM MSG S&gt;2WAY REC SMDI S&gt;REC USER GREET S&gt;LISTEN TM / DT S&gt;LISTEN STA NUM ----- STA 102 (T) NOV 02 01:40pm                     </pre> </div> <ul style="list-style-type: none"> <li>• <i>Date &amp; Time Prompt;</i></li> <li>• Select LISTEN TM / DT key in the above display.</li> <li>• You will hear the time prompt, "Date is December, 20th, Time is XX : XX PM."</li> <li>• <i>Station Number Prompt :</i></li> <li>• Select LISTEN STA NUM key in the above display.</li> <li>• You will hear the station number prompt, "This is station XXXX."</li> <li>• <i>Station Status Prompt :</i></li> <li>• Press <b>PAGE</b> down(▼) key again in the above display, you will see the following.</li> </ul> <div style="border: 1px solid black; padding: 5px; margin: 10px 0;"> <pre> S&gt;LISTEN STA STAT S&gt;RECORD PG MSG S&gt;ERASE USER GRT S&gt;ERASE PAGE MSG S&gt;LCD DISP LANG ----- STA 102 (T) NOV 02 01:40pm                     </pre> </div> <ul style="list-style-type: none"> <li>• Select LISTEN STA STAT key. Then you will hear station status.</li> <li>• <i>Record VMIB Paging Message :</i></li> <li>• Select RECORD PG MSG key in the above display.</li> <li>• <i>Erase your User Greeting :</i></li> <li>• Select ERASE USET GRT key in the above display.</li> <li>• <i>ERASE VMIB Paging Message :</i></li> <li>• Select ERASE PAGE MSG key in the above display.</li> </ul>	



## CO Message Wait

When a call is received with DISA/DID, the Calling Line Identification (CLI) of the incoming call is displayed on the LCD of the station. If the DISA/DID external party hangs up the call before answered, the CLI will be stored in the CO message wait queue in the called party.

Button	Procedures	Range
	<p><i>To retrieve CLI Message,</i></p> <ul style="list-style-type: none"> <li>• Press <b>CALLBK</b> button.</li> <li>• The stored message will be shown on the LCD.</li> </ul>	
	<p><i>To delete the current CLI message and see the next one,</i></p> <ul style="list-style-type: none"> <li>• Press <b>CONF</b> button.</li> </ul>	
	<p><i>To make a callback,</i></p> <ul style="list-style-type: none"> <li>• Press <b>HOLD/SAVE</b> button.</li> <li>• The stored number is dialed as speed dialing.</li> </ul>	
	<p><i>To see the next/previous CLI message,</i></p> <ul style="list-style-type: none"> <li>• Press <b>VOLUME</b> button.</li> </ul> <p><i>To delete all CLI messages, (Not available in Aria-16/20W)</i></p> <ul style="list-style-type: none"> <li>• Press <b>SPEED</b> button twice.</li> <li>• If DVU message is stored with CLI message, the CLI message will not be deleted by pressing SPEED button.</li> </ul>	

## DISA (Direct Inward System Access)

Outside caller can access a CO line which is programmed as DISA line.



Button	Procedures	Range
	<ul style="list-style-type: none"> <li>• Dial the CO access code after hearing dial tone or voice guide from DVU.</li> <li>• Or, dial the CO access code after dialing the programmed authorization code (when needed) for outgoing call.</li> </ul>	

## LCD Language Change

Button	Procedures	Range
	<ul style="list-style-type: none"> <li>• Press <b>TRANS/PGM</b> button and dial <b>5 1</b> (<i>Aria-300/130: 7 1</i>).</li> <li>• The language in LCD is changed into default value.</li> <li>• If pressing <b>TRANS/PGM + 5 1</b> (<i>Aria-300/130: 7 1</i>), the language in the LCD is changed to the nation's language.</li> </ul>	16: Above V4.0 20W: Above V3.0



## Alarm Reset

Button	Procedures	Range
	<p>To terminate alarm signal while idle state,</p> <ul style="list-style-type: none"> <li>• Dial <b>6 5</b> (<i>Aria-300/130: 5 6 5</i>).</li> <li>• Confirmation tone is heard and the alarm signal is terminated at all assigned stations.</li> </ul> <p><i>Or using display, (Only in KD-33LD, KD/E-36LD, LKD-30LD)</i></p>	
	<ul style="list-style-type: none"> <li>• Press the 4th menu key from main menu to select FEATURE.</li> <li>• Press <b>PAGE</b> down(▼) key twice. On the display, you will see the following.</li> </ul> <div style="border: 1px solid black; padding: 5px; margin: 10px 0;"> <ul style="list-style-type: none"> <li>■ ACC CO-GR(01-48) ■</li> <li>■ ACC 1 CO(01-96) ■</li> <li>■ UNIV NITE ANSWER ■</li> <li>■ TIE ROUTE (01-30) ■</li> <li>■ ALARM RESET ■</li> <li>.....</li> <li style="text-align: center;">STA 102 (T) ▲</li> <li>▣ NOV 02 01:40pm ▼</li> </ul> </div> <ul style="list-style-type: none"> <li>• Select ALARM RESET key.</li> <li>• Ring is stopped.</li> </ul> <p><i>In Aria-300/130, (Only in KD-33LD, KD/E-36LD, LKD-30LD)</i></p>	
	<ul style="list-style-type: none"> <li>• Press the 4th menu key from main menu to select FEATURE.</li> <li>• Press <b>PAGE</b> down(▼) key 3 times. On the display, you will see the following.</li> </ul> <div style="border: 1px solid black; padding: 5px; margin: 10px 0;"> <ul style="list-style-type: none"> <li>■ GROUP PICKUP ■</li> <li>■ DIR PICKUP (STA#) ■</li> <li>■ ALARM RESET ■</li> <li>■ DOOR OPEN ■</li> <li>.....</li> <li style="text-align: center;">STA 102 (T) ▲</li> <li>▣ NOV 02 01:40pm ▼</li> </ul> </div> <ul style="list-style-type: none"> <li>• Select ALARM RESET key.</li> <li>• Ring is stopped.</li> </ul>	

Large LCD

## Two-way Recording (Only in Aria-300/130, Aria-16/20W)

While a CO line call, you can record the conversation and it will be saved in its own mailbox.

Button	Procedures	Range
	<p><i>To record the conversation,</i></p> <ul style="list-style-type: none"> <li>• Press the programmed {RECORD} button.</li> </ul> <p><i>To program the {RECORD} button,</i>                      [TRANS/PGM] + Flex. BTN + [TRANS/PGM] + # 4 (Aria-300/130: <b>5 4</b>) + [HOLD/SAVE]</p> <p><i>To finish the recording,</i></p> <ul style="list-style-type: none"> <li>• Press the programmed {RECORD} button again. Or, replace the handset.</li> </ul>	

## Large LCD Keypad Features

*The following features are operated only KD-33LD, KD/E-36LD and LKD-30LD. (Large LCD Digital Keypad)*



## LCD Brightness Control ( \* )

Button	Procedures	Range
	<ul style="list-style-type: none"> <li>• Press the 5th menu key from main menu.</li> <li>• Select LCD BRIGHTNESS.</li> <li>• Press <b>VOLUME</b> button (▲/▼) to control the brightness.</li> </ul>	

## Calendar Display

Button	Procedures	Range																																																																																		
	<ul style="list-style-type: none"> <li>• Press <b>MENU</b> key to display Calendar.</li> </ul> <p>On the display, you will see calendar as follows;</p> <div style="border: 1px solid black; padding: 5px; margin: 10px 0;"> <p style="text-align: center;">MAR 2001</p> <table style="width: 100%; border-collapse: collapse;"> <tr> <td style="width: 12.5%; text-align: center;">■</td> <td style="width: 12.5%; text-align: center;">S</td> <td style="width: 12.5%; text-align: center;">M</td> <td style="width: 12.5%; text-align: center;">T</td> <td style="width: 12.5%; text-align: center;">W</td> <td style="width: 12.5%; text-align: center;">T</td> <td style="width: 12.5%; text-align: center;">F</td> <td style="width: 12.5%; text-align: center;">S</td> <td style="width: 12.5%; text-align: center;">■</td> </tr> <tr> <td></td> <td></td> <td></td> <td></td> <td></td> <td></td> <td style="text-align: center;">1</td> <td style="text-align: center;">2</td> <td style="text-align: center;">3</td> <td></td> </tr> <tr> <td></td> <td style="text-align: center;">4</td> <td style="text-align: center;">5</td> <td style="text-align: center;">6</td> <td style="text-align: center;">7</td> <td style="text-align: center;">8</td> <td style="text-align: center;">9</td> <td style="text-align: center;">10</td> <td></td> </tr> <tr> <td></td> <td style="text-align: center;">11</td> <td style="text-align: center;">12</td> <td style="text-align: center;">13</td> <td style="text-align: center;">14</td> <td style="text-align: center;">15</td> <td style="text-align: center;">16</td> <td style="text-align: center;">17</td> <td></td> </tr> <tr> <td></td> <td style="text-align: center;">18</td> <td style="text-align: center;">19</td> <td style="text-align: center;">20</td> <td style="text-align: center;">21</td> <td style="text-align: center;">22</td> <td style="text-align: center;">23</td> <td style="text-align: center;">24</td> <td></td> </tr> <tr> <td></td> <td style="text-align: center;">25</td> <td style="text-align: center;">26</td> <td style="text-align: center;">27</td> <td style="text-align: center;">28</td> <td style="text-align: center;">29</td> <td style="text-align: center;">30</td> <td style="text-align: center;">31</td> <td></td> </tr> <tr> <td></td> <td colspan="7" style="text-align: center;">.....</td> <td></td> </tr> <tr> <td></td> <td colspan="7" style="text-align: center;">STA 102 (T)</td> <td style="text-align: center;">▲</td> </tr> <tr> <td style="text-align: center;">■</td> <td style="text-align: center;">MAR 02</td> <td colspan="5"></td> <td style="text-align: center;">01:40pm</td> <td style="text-align: center;">▼</td> </tr> </table> </div> <ul style="list-style-type: none"> <li>• While the calendar is displayed, the main menu key and other menu keys will not work.</li> <li>• To display the main menu instead of calendar, press <b>MENU</b> key.</li> </ul>	■	S	M	T	W	T	F	S	■							1	2	3			4	5	6	7	8	9	10			11	12	13	14	15	16	17			18	19	20	21	22	23	24			25	26	27	28	29	30	31			.....									STA 102 (T)							▲	■	MAR 02						01:40pm	▼	
■	S	M	T	W	T	F	S	■																																																																												
						1	2	3																																																																												
	4	5	6	7	8	9	10																																																																													
	11	12	13	14	15	16	17																																																																													
	18	19	20	21	22	23	24																																																																													
	25	26	27	28	29	30	31																																																																													
	.....																																																																																			
	STA 102 (T)							▲																																																																												
■	MAR 02						01:40pm	▼																																																																												

## Door Open

Button	Procedures	Range
	<ul style="list-style-type: none"> <li>• Press the 4th menu key from main menu to select FEATURE.</li> <li>• Press <b>PAGE</b> down(▼) key 3 times.</li> </ul> <p>On the display, you will see the following.</p> <div style="border: 1px solid black; padding: 5px; margin: 10px 0;"> <ul style="list-style-type: none"> <li>■ DOOR OPEN (1-4) ■</li> <li>■ DVU RECORD ■</li> <li>■ DVU DELETE ■</li> <li>■ DVU STA STATUS ■</li> <li>■ DVU PLAY ■</li> <li>.....</li> <li style="text-align: center;">STA 102 (T) ▲</li> <li>■ NOV 02 01:40pm ▼</li> </ul> </div> <ul style="list-style-type: none"> <li>• Select DOOR OPEN(1-4) key.</li> <li>• Select the door open type by pressing dial button 1~4.</li> </ul>	
<i>In Aria-300/130, (Only in KD-33LD, KD/E-36LD, LKD-30LD)</i>		
	<ul style="list-style-type: none"> <li>• Press the 4th menu key from main menu to select FEATURE.</li> <li>• Press <b>PAGE</b> down(▼) key 3 times.</li> </ul> <p>On the display, you will see the following.</p> <div style="border: 1px solid black; padding: 5px; margin: 10px 0;"> <ul style="list-style-type: none"> <li>■ GROUP PICKUP ■</li> <li>■ DIR PICKUP (STA#) ■</li> <li>■ ALARM RESET ■</li> <li>■ DOOR OPEN ■</li> <li>.....</li> <li style="text-align: center;">STA 102 (T) ▲</li> <li>■ NOV 02 01:40pm ▼</li> </ul> </div> <ul style="list-style-type: none"> <li>• Select DOOR OPEN (1-7) key.</li> <li>• Select the door open type by pressing dial button 1~7.</li> </ul>	Aria-130 : 1-6

### Station Programming Menu Table (Aria-300/130)

The Aria-300/130 system supports multiple hierarchical menus based on station programming. User can make station programming by selecting desired menu. By pressing [TRANS/PGM] button in a keyset with LCD, user can see the menu.

Main Menu	Sub Menu	Sub Menu-2	Selection	Remark
[1] RING	[1] TYPE		1,2,3,4	DKTU
	[2] ANSWER MODE		H(1)/T(2)/P(3)	
[2] COS	[1] COS DOWN		ICM/COS7	
	[2] COS RESTORE		ENTER AUTHO CODE	
	[3] WALKING COS		ENTER AUTHO CODE	
[3] AUTHORIZATION	[1] AUTH REGISTER			
	[2] AUTH CHANGE			
[4] TIME	[1] SET WAKE UP TIME		ONCE/ PERMERNANT	
	[2] WAKE UP DISABLE			
[5] MESSAGE	[1] SET PRESELECTED MSG		00 - 10	
	[2] SET CUSTOMER MSG		None	
[6] ANNOUNCEMENT	[1] RECORD USER GREETING			
	[2] LISTEN TIME&DATE			
	[3] LISTEN STA NUMBER			
	[4] LISTEN STA STATUS			
	[5] RECORD PAGE MSG			
	[6] ERASE USER GREETING			
	[7] ERASE PAGE MSG			
[7] SUPPLEMENTARY	[1] LCD DISPLAY LANGUAGE		DOMESTIC/ ENGLISH	DKTU
	[2] MPB VERSION DISPLAY			
	[3] BGM			
	[4] REGISTER STA NAME			2/8 BTN/SLT
	[5] SPK/HEADSET		SPEAKER/HEADSET	
	[6] HEADSET RING MODE		SPEAKER/HEADSET/ BOTH	
	[7] WTU STA NUM RCVR			
	[8] SERIAL NUMBER			
[0] ATTENDANT				ATD ONLY
[*] SYSTEM	[#] ENTER ADMIN			ADMIN ONLY





**Code for Flexible Button Programming (Aria-300/130)**

Direct Station Select	station number Aria-300:100 ~ 399 Aria-130:100 ~ 227	Ring Type	TRANS/PGM + 11
Call Park	parking location Aria-300: 601 ~ 619 Aria-130: 601 ~610	Ring Answer Mode	TRANS/PGM + 12
Hunt Group	internal hunt group Aria-300:620 ~ 667 Aria-130:620 ~ 634	COS Down	TRANS/PGM + 21
Alarm Reset	5 6 5	COS Restore	TRANS/PGM + 22
Group Call Pick-up	5 6 6	Walking COS	TRANS/PGM + 23
Universal Night Answer	5 6 9	Auth. Code Register	TRANS/PGM + 31
Speed Dial		Auth. Code Change	TRANS/PGM + 32
Station speed dial	SPEED+000~099	Set Wake-up Time	TRANS/PGM + 41
System speed dial	Aria-300: SPEED+2000~4999 Aria-130: SPEED+2000~3499	Wake-up Disable	TRANS/PGM + 42
Outside Line Access		Set Preselected MSG	TRANS/PGM + 51
Group access	9	Set Customer MSG	TRANS/PGM + 52
Group #1~72	Aria-300:8 0 1~8 7 2 Aria-130:8 0 1~8 2 4	Record User Greeting	TRANS/PGM + 61
Individual Line Access	Aria-300: 8 8+001~200 Aria-130: 8 8+01~40	Listen Time & Date	TRANS/PGM + 62
Alarm Reset	5 6 5	Listen Station Number	TRANS/PGM + 63
		Listen Station Status	TRANS/PGM + 64
		Record Page MSG	TRANS/PGM + 65
		Erase User Greeting	TRANS/PGM + 66
		Erase Page MSG	TRANS/PGM + 67
		LCD Display Language	TRANS/PGM + 71
		MPB Version Display	TRANS/PGM + 72
		Background Music	TRANS/PGM + 73
		Register Station Name	TRANS/PGM + 74
		Speakerphone/Headset	TRANS/PGM + 75
		Headset Ring Mode	TRANS/PGM + 76
		Account Code	TRANS/PGM + 80
		ICM Hold	TRANS/PGM + 83
		LOOP button	TRANS/PGM + 84
		Camp-on	TRANS/PGM + 85
<b>Button Assignment for LKD-2/8 button</b>			
CONF button	TRANS + 9 1		
CALLBK button	TRANS + 9 2		
DND button	TRANS + 9 3		
FLASH button	TRANS + 9 4		
MUTE button	TRANS + 9 5		
MON button	TRANS + 9 6		
REDIAL button	TRANS + 9 7		

**Information**

- . You cannot use large LCD digital keyset in Aria-16/20W.
- . Programming flexible buttons for the following features are not supported in Aria-16/20W (marked ( \* )).
- Dial Memo
- Access Authorization Code
- Pre-selected Message
- Stop Watch Event Timer
- Account Code

## Wake-up Call

Button	Procedures
	<p><i>To register wake-up call,</i></p> <ul style="list-style-type: none"> <li>• Press <b>TRANS/PGM</b> button.</li> <li>• Dial <b>4 1</b> (<i>Aria-300/130: 0 4 2</i>).</li> <li>• Dial the station range. In case of one station, dial the station number twice.</li> <li>• After hearing confirmation tone, enter 4-digit wake-up time (HHmm) in 24-hour mode. (HH= 00~23, mm= 00~59)</li> <li>• Press <b>HOLD/SAVE</b> button for one-day, or dial # and <b>HOLD/SAVE</b> button for until canceled.</li> </ul>
	





Or using display, (*Only in KD-33LD, KD/E-36LD, LKD-30LD*)

<ul style="list-style-type: none"> <li>• Press the 5th menu key from the main menu to select PROGRAM. On the display, you'll see the following.</li> </ul>	<pre> ■ ATD PROGRAM ■ ■ STATION PROGRAM ■ ■ LCD BRIGHTNESS ■ ■ RING VOLUME ■ ■ SPEAKER VOLUME ■ .....           STA 102 (T) ▲           NOV 02  01:40pm ▼         </pre>
<ul style="list-style-type: none"> <li>• Select the ATD PROGRAM. On the display, you'll see the following.</li> </ul>	<pre> ■ A&gt;WAKE-UP SET ■ ■ A&gt;WAKE-UP ERASE ■ ■ A&gt;PASSWORD ERASE ■ ■ A&gt;CHG DATE MODE ■ ■ A&gt;CHG TIME MODE ■ .....           STA 102 (T) ▲           NOV 02  01:40pm ▼         </pre>

In Aria-300/130, (*Only in KD-33LD, KD/E-36LD, LKD-30LD*)

<ul style="list-style-type: none"> <li>• Press the 5th menu key from the main menu to select PROGRAM. On the display, you'll see the following.</li> </ul>	<pre> ■ ATD PROGRAM ■ ■ STATION PROGRAM ■ ■ LCD BRIGHTNESS ■ ■ RING VOLUME ■ ■ SPEAKER VOLUME ■ .....           STA 102 (T) ▲           NOV 02  01:40pm ▼         </pre>
<ul style="list-style-type: none"> <li>• Select the ATD PROGRAM and <b>PAGE</b> down(▼) key 4 times. On the display, you'll see the following.</li> </ul>	<pre> ■ A&gt;CHNG DATE/TIME ■ ■ A&gt;SET WAKE UP ■ ■ A&gt;DISBL WAKE UP ■ ■ A&gt;LCD DATE MODE ■ ■ A&gt;LCD TIME MODE ■ .....           STA 102 (T) ▲           NOV 02  01:40pm ▼         </pre>
<ul style="list-style-type: none"> <li>• Select the SET WAKE-UP key.</li> </ul>	

**Wake-up Call** (Cont'd)

Button	Procedures
	<ul style="list-style-type: none"> <li>• Enter the station range (XXX-YYY) to receive wake-up call.</li> <li>• Enter 4-digit wake-up time (HHmm) in 24-hour mode.</li> <li>• Press <b>HOLD/SAVE</b> button for one-day, or dial # and <b>HOLD/SAVE</b> button for until canceled.</li> </ul>
	<p><i>To cancel wake-up call,</i></p> <ul style="list-style-type: none"> <li>• Press <b>TRANS/PGM</b> button.</li> <li>• Dial <b>4 2</b> (<i>Aria-300/130: 0 4 3</i>).</li> </ul>
	<p>(Confirmation tone is heard and <b>MON</b> button is lighting.)</p> <ul style="list-style-type: none"> <li>• Dial the station range to be canceled.</li> <li>• Press <b>HOLD/SAVE</b> button. (<b>MON</b> button will be extinguished.)</li> </ul>
<p><i>Or using display, (Only in KD-33LD, KD/E-36LD, LKD-30LD)</i></p>	
	<ul style="list-style-type: none"> <li>• Press the 5th menu key from the main menu.</li> <li>• Select the ATD PROGRAM.</li> <li>• Select the WAKE-UP ERASE key.</li> <li>• Enter the station range to be canceled (XXX~YYY).</li> <li>• Press <b>HOLD/SAVE</b> button.</li> </ul>
<p><i>In Aria-300/130, (Only in KD-33LD, KD/E-36LD, LKD-30LD)</i></p>	
	<ul style="list-style-type: none"> <li>• Press the 5th menu key from the main menu.</li> <li>• Select the ATD PROGRAM and <b>PAGE</b> down(▼) key 4 times.</li> <li>• Select the DISBL WAKE UP key.</li> <li>• Enter the station range to be canceled (XXX~YYY).</li> <li>• Press <b>HOLD/SAVE</b> button.</li> </ul>

Attendant Operation



## System Greetings

It provides announcements for Hunt service (UCD/Circular/Terminal) or DISA and only the system attendant can record this message.

Button

Procedures



- Press **TRANS/PGM** button.
- Dial **# 4**.
- For DVU, dial 0 1 for announcement 1, dial 0 2 for announcement 2, or 0 3 for announcement 3. (Announcement 3 is played back when the called party is busy.)
- For EDVU, you have 31 (01~31) system greetings;
  - 1~9 : for Hunt or company information with DISA
  - 10 : for Invalid message
  - 11 : for Time-out message
  - 12 : for Try again message
  - 13 : for Transfer to attendant message
  - 14 : for Leave message
  - 15 : for Record message
  - 16 : for Enter authorization message
  - 17 : for MOH message
  - 18 : for Busy message
  - 20 : for STA off-net announcement message
- Press **#** (to record with DKTU) button or **\*** (to record with external MOH) button after hearing the message.
- Record your greeting and hang up to finish the recording.
- To delete, press **DND/FWD** button while the message is played.

In Aria-16/20W,



- Press **TRANS/PGM** button.
- Dial **# 4**.
- Select the announcement type.  
(1: System Greeting, 2: System Prompt)
- Dial the announcement number.
- Dial the source number (1: external MOH, 2: DKTU)
- Dial **#** to start recording.
- Press **HOLD/SAVE** button.
- You have 19 System Greetings and 9 Prompts;
  - System Greetings (Announcement Type 1)
    - 1: Day Time System Greeting
    - 2: Night Time System Greeting
    - 3: Circular & Terminal Hunt Group Greeting
    - 4: 1st UCD Group Announcement
    - 5: 2nd UCD Group Announcement
    - 6: Ring Group Announcement (Aria-16: version 4.0XX, 20W: version 3.0XX)
    - 7: DVIB MOH
    - 8: SLT Message Waiting Indication Announcement  
(Aria-16: version 4.0XX, 20W: version 3.0XX)
    - 9: Off-Net Forward Announcement (Aria-16: version 4.0XX, 20W: version 3.0XX)
    - 10: Group Overflow Announcement (Aria-16: version 4.0XX, 20W: version 3.0XX)
    - 11-19: CCR Announcement (Aria-16: version 4.0XX, 20W: version 3.0XX)
  - System Prompts (Announcement Type 2)
    - 1: Timeout Prompt
    - 2: Retry Prompt
    - 3: Busy Prompt
    - 4: DND Prompt
    - 5: Invalid Prompt
    - 6: No Answer Prompt
    - 7: Transfer to Attendant Prompt
    - 8: Authorization Code Prompt
    - 9: Record Start Prompt
- To delete announcement, dial the announcement number and **#**.

**System Greetings (Aria-300/130) (Cont'd)**

Button	Procedures
--------	------------

*In Aria-300/130,*



*To record system greetings,*

- Press **TRANS/PGM** button.
- Dial **0 6**.
- Dial the announcement number (001~100).
- “Press # button to record” is heard. Then press # button to start recording.
- Record your greeting and press **HOLD/SAVE** button to finish the recording.
- To delete, press **SPEED** button while the message is played.

- The System Prompt messages are 071~100 as default;

071: VMIB MOH	086: Reserved
072: Reserved	087: Reserved
073: Invalid Number Prompt	088: Remote VMIB Control Main Menu Prompt
074: Time out Prompt	089: Remote VMIB Sub-menu for digit 1 in Main Menu Prompt
075: Retry Prompt	090: Reserved
076: Transfer to Attendant Prompt	091: Reserved
077: Reserved	092: Reserved
078: Leave Message Prompt	093: Remote VMIB Sub-menu for digit 2 in Main Menu Prompt
079: Record Start Prompt	094: Remote VMIB Sub-menu for digit 3 in Main Menu Prompt
080: Authorization Code Prompt	095: Remote VMIB Sub-menu for digit * in Main Menu Prompt
081: Busy Prompt	096: Leave Message after Tone Prompt
082: Reserved	097~100: Reserved
083: Station Off-net Forward Prompt	
084: DND Prompt	
085: No Answer Prompt	

Attendant Operation

**Attendant Clock Set**

This feature allows the attendant to set the Time/Date without entering Admin Programming.

Button	Procedure
--------	-----------



- Press **TRANS/PGM** button.
- Dial **# 1**.
- Enter Date + Time. Enter as YYMMDDHHmm.  
(YY= Year 00~99, MM= Month 01~12, DD= Date 01~31, HH= Hour 00~23, mm= minute 00~59)  
If there is no need to change date or time, press \* key.  
(YYMMDD + \* or \* + HHmm)
- Press **HOLD/SAVE** button.

*In Aria-16/20W, Aria-300/130,*

- Press **TRANS/PGM** button.
- Dial **# 1** (*Aria-300/130: 0 4 1*).
- Enter Date as MMDDYY (6 digits) and press **HOLD/SAVE** button.
- Enter Time as military format (4 digits) and press **HOLD/SAVE** button.  
If there is no need to change date or time, press **HOLD/SAVE** button to go to the next step.

## Changing Time/Date Format

Button	Procedure
	<p><i>To change the date format on the LCD,</i></p> <ul style="list-style-type: none"> <li>• Press <b>TRANS/PGM</b> button.</li> <li>• Dial * <b>5</b> (<i>Aria-300/130: 0 4 4</i>).</li> <li>• The format toggles between DDMMYY and MMDDYY. (YY : year, MM : month, DD : date)</li> </ul>

*Or using display, (Only in KD-33LD, KD/E-36LD, LKD-30LD)*

- Press the 5th menu key from the main menu to select PROGRAM.
- Select the ATD PROGRAM key.
- On the display, you'll see the following.
 

```

                ■ A>WAKE-UP SET          ■
                ■ A>WAKE-UP ERASE      ■
                ■ A>PASSWORD ERASE     ■
                ■ A>CHG DATE MODE      ■
                ■ A>CHG TIME MODE      ■
                .....
                STA 102 (T)
                ■ NOV 02 01:40pm      ■
            
```
- Select the CHG DATE MODE key.
- The format toggles between DDMMYY and MMDDYY.  
(YY : year, MM : month, DD : date)

*In Aria-300/130, (Only in KD-33LD, KD/E-36LD, LKD-30LD)*

- Press the 5th menu key from the main menu to select PROGRAM.  
On the display, you'll see the following.
 

```

                ■ ATD PROGRAM          ■
                ■ STATION PROGRAM      ■
                ■ LCD BRIGHTNESS       ■
                ■ RING VOLUME          ■
                ■ SPEAKER VOLUME       ■
                .....
                STA 102 (T)
                ■ NOV 02 01:40pm      ■
            
```
- Select the ATD PROGRAM and **PAGE** down(▼) key 4 times.  
On the display, you'll see the following.
 

```

                ■ A>CHNG DATE/TIME    ■
                ■ A>SET WAKE UP       ■
                ■ A>DISBL WAKE UP     ■
                ■ A>LCD DATE MODE     ■
                ■ A>LCD TIME MODE     ■
                .....
                STA 102 (T)
                ■ NOV 02 01:40pm      ■
            
```
- Select the LCD DATE MODE key.
- The format toggles between DDMMYY and MMDDYY.  
(YY : year, MM : month, DD : date)

## Changing Time/Date Format (Cont'd)



Button	Procedure
	<p><i>To change the time format on the LCD,</i></p> <ul style="list-style-type: none"> <li>• Press <b>TRANS/PGM</b> button.</li> <li>• Dial * <b>6</b> (<i>Aria-300/130: 0 4 5</i>).</li> <li>• The format toggles between 12-hour mode and 24-hour mode. (YY : year, MM : month, DD : date)</li> </ul>
<p><i>Or using display, (Only in KD-33LD, KD/E-36LD, LKD-30LD)</i></p>	
	<ul style="list-style-type: none"> <li>• Press the 5th menu key from the main menu to select PROGRAM.</li> <li>• Select the ATD PROGRAM key.</li> <li>• Select the CHG TIME MODE key. The format toggles between 12 and 24-hour mode.</li> </ul>
<p><i>In Aria-300/130, (Only in KD-33LD, KD/E-36LD, LKD-30LD)</i></p>	
	<ul style="list-style-type: none"> <li>• Press the 5th menu key from the main menu to select PROGRAM.</li> <li>• Select the ATD PROGRAM key <b>PAGE</b> down(▼) key 4 times. .</li> <li>• Select the LCD TIME MODE key. The format toggles between 12 and 24-hour mode.</li> </ul>

## To Set Current Time 1 Hour Early/Late (Only in Aria-16/20W)

Button	Procedure
	<p><i>To set the current time 1 hour early,</i></p> <ul style="list-style-type: none"> <li>• Press <b>TRANS/PGM</b> button.</li> <li>• Dial * <b>1</b>.</li> </ul> <p><i>To set the current time 1 hour late,</i></p> <ul style="list-style-type: none"> <li>• Press <b>TRANS/PGM</b> button.</li> <li>• Dial * <b>2</b>.</li> </ul>

## System Speed Dial



A group of speed dial numbers can be stored within the system for access by allowed stations. These numbers provide speedy access to often used outgoing CO dialing numbers.

Button	Procedure
  	<p><i>To store system speed numbers,</i></p> <ul style="list-style-type: none"> <li>• Press <b>TRANS/PGM</b> button.</li> <li>• Dial <b>SPEED</b> button.</li> <li>• Dial <u>speed number bin</u>.</li> <li>• Dial the phone numbers to be stored.</li> <li>• Dial <b>HOLD/SAVE</b> button.</li> </ul> <p style="text-align: center;"><i>Or,</i></p> <ul style="list-style-type: none"> <li>• Press <b>TRANS/PGM</b> button.</li> <li>• Dial <b>SPEED</b> button.</li> <li>• Dial <u>speed number bin</u>.</li> <li>• Press desired outside line button.</li> <li>• Dial the phone numbers to be stored.</li> <li>• Dial <b>HOLD/SAVE</b> button.</li> </ul> <p><i>To use system speed numbers,</i></p> <ul style="list-style-type: none"> <li>• Press <b>SPEED</b> button.</li> <li>• Dial <u>speed number bin</u>.</li> </ul>

Aria-300 : 2000~4999  
 Aria-130 : 2000~3499  
 Aria-186 : 200~999  
           100 : 200~399  
           34e : 200~399  
 16/20W : 21~99

## Attendant Intrusion



Attendant may intrude into any station which is in conversation with a CO line.

Button	Procedure
 	<p><i>To assign a flexible key as the Intrusion button</i> (Not available in Aria-16/20W),</p> <ul style="list-style-type: none"> <li>• Press <b>TRANS/PGM</b> button.</li> <li>• Press the desired flexible key to be registered.</li> <li>• Press <b>TRANS/PGM</b> button.</li> <li>• Dial <b>8 6</b>.</li> <li>• Press <b>HOLD/SAVE</b> button.</li> </ul> <p><i>To activate attendant intrusion (Aria-300/130, Aria-186/100/34e),</i></p> <ul style="list-style-type: none"> <li>• Press DSS button corresponding to the busy station you wish to call. (Busy tone is heard.)</li> <li>• Press ATD INTRUSION button. (Intrusion warning tone is heard in the busy station, then a 3-way conference is set up.)</li> </ul> <p><i>To activate attendant intrusion (Aria-16/20W),</i></p> <ul style="list-style-type: none"> <li>• Press CO button you wish to converse. (If intrusion is allowed by Admin program, then 3 way conversation is set up. If intrusion is not allowed, busy tone will be heard.)</li> <li>• System Base Program (Main Menu 5) - System Attribute (Sub Menu 1)   - Privacy (Terminal Menu 2)</li> </ul>

### Day/On-demand/Night Mode Service (Manual/Automatic)



The attendant station can be placed into night service mode allowing ring assignments and answering privileges to station not having the privileges in the day mode. Or, can be placed into on-demand service mode allowing ring assignments and answering privileges to station not having the privileges in the night mode.

(In Aria-16, only Day/Night mode change is available by pressing DND button at attendant station.)

Button	Procedures
	<p><i>To activate/deactivate Day/Night/On-demand mode manually,</i></p> <ul style="list-style-type: none"> <li>• Press <b>DND/FWD</b> button at attendant station.</li> <li>• Then, <b>DND/FWD</b> button is flashing. (The system is placed into On-demand mode.)</li> <li>• If pressing the <b>DND</b> button one more, then the system is placed into Night service mode.</li> <li>• On-demand mode is not activated automatically.</li> </ul>
	<p><i>To change Day/Night mode automatically,</i></p> <ul style="list-style-type: none"> <li>• Press <b>TRANS/PGM</b> button.</li> <li>• Dial # <b>9</b>.</li> <li>• Enter DAY TIME + NIGHT TIME, or DAY TIME + * or * + NIGHT TIME . (Enter as HHmm (HH= hour 00~23, mm= minute 00~59)</li> <li>• Press <b>HOLD/SAVE</b> button.</li> </ul>
	

### Day/On-demand/Night/Weekend Mode Service (Aria-300/130)

The system can be placed in Day/On-demand/Night/Weekend/Auto mode operation manually by pressing [DND/FWD] button at attendant station. In Auto ring mode, the ring mode will follow the Weekly Time Table (PGM 233).

Button	Procedures
	<p><i>To activate/deactivate Day/Night/On-demand/Weekend/Auto mode manually,</i></p> <ul style="list-style-type: none"> <li>• Pressing <b>DND/FWD</b> button, the ring mode is changed to <b>On-demand → Night → Weekend → Auto → Day</b> mode in sequence.</li> <li>• On-demand mode is not activated automatically.</li> </ul>
	<p><i>To activate Auto ring mode with Attendant PGM mode,</i></p> <ul style="list-style-type: none"> <li>• Press <b>TRANS/PGM</b> button.</li> <li>• Dial <b>0 7 4</b>.</li> <li>• Dial <b>1</b> and press <b>HOLD/SAVE</b> button. (The Weekly Time Table should be entered by Admin Programming.)</li> </ul>
	

### Day//Night/Auto Ring Mode Service (Aria-16/20W)

The system can be placed in Day/Night/Auto Ring mode operation manually by pressing [DND/FWD] button at attendant station. In Auto ring mode, the ring mode will follow the Weekly Time Table in Admin Programming(Main 5- Sub21 ).

Auto Ring mode is available for ver 4.0XX(Aria-16) and 3.0XX(Aria-20W)



Button	Procedures
	<p><i>To activate/deactivate Day/Night/Auto Ring mode manually,</i></p> <ul style="list-style-type: none"> <li>Pressing <b>DND/FWD</b> button, the ring mode is changed to <b>Night → Auto Ring → Day</b> mode in sequence.</li> </ul> <p><i>To activate Auto ring mode with Attendant PGM mode,</i></p> <ul style="list-style-type: none"> <li>The Weekly Time Table should be entered by Admin Programming</li> </ul>

### To Print out Accumulated SMDR Records

Station Message Detail Recording(SMDR) can provide details on both incoming and outgoing calls.

Button	Procedures
	<p><i>For station basis,</i></p> <p style="text-align: right;">(Aria 16: Above V4.0 20W : Above V3.0)</p> <p>(Aria-300/130: <b>TRANS/PGM + 0 1 1 1</b>, Aria-16/20W: <b>TRANS/PGM + * 8 1</b>)</p> <ul style="list-style-type: none"> <li>Dial * <b>0</b></li> <li>Enter the desired station range.</li> <li>Press <b>HOLD/SAVE</b> button.</li> </ul> <p>Accumulated SMDR records will be printed out through the printer connected to KSU.</p>

Or using display, **(Only in KD-33LD, KD/E-36LD, LKD-30LD)**

	<ul style="list-style-type: none"> <li>Press the 4th menu key from the main menu to select FEATURE. On the display, you will see the following.</li> </ul> <div style="border: 1px solid black; padding: 5px; margin: 10px 0;"> <ul style="list-style-type: none"> <li>■ INT PAGE (01-20) ■</li> <li>■ INT ALL CALL ■</li> <li>■ EXT ALL CALL ■</li> <li>■ INT/EXT ALL CALL ■</li> <li>■ MEET ME ■</li> <li>.....</li> <li>□ STA 102 (T) ▲</li> <li>NOV 02 01:40pm ▼</li> </ul> </div> <div style="border: 1px solid black; padding: 5px; margin: 10px 0;"> <ul style="list-style-type: none"> <li>■ STA PRT SMDR ■</li> <li>■ ACT GRD PRT SMDR ■</li> <li>■ STA DEL SMDR ■</li> <li>■ ACT GRP DEL SMR ■</li> <li>■ DISP CALL CHARGE ■</li> <li>.....</li> <li>□ STA 102 (T) ▲</li> <li>NOV 02 01:40pm ▼</li> </ul> </div>
	<ul style="list-style-type: none"> <li>Select STA PRT SMDR key.</li> <li>Enter the desired station range to be printed.</li> <li>Press <b>HOLD/SAVE</b> button.</li> </ul>

**To Print out Accumulated SMDR Records (Cont'd)**

Button	Procedures
--------	------------

*In Aria-300/130, (Only in KD-33LD, KD/E-36LD, LKD-30LD)*

- Press the 5th menu key from the main menu to select PROGRAM.  
On the display, you will see the following.

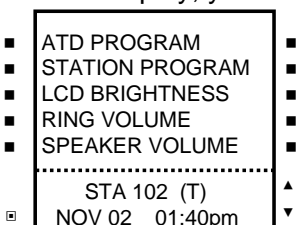

- Select ATD PROGRAM key. On the display, you will see the following.

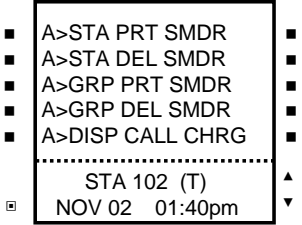

- Select STA PRT SMDR key.
- Enter the desired station range to be printed.
- Press **HOLD/SAVE** button.



*For account group basis,*

- Dial \* 1 (*Aria-300/130: TRANS/PGM + 0 1 1 3*).
- Enter the desired account group to be printed.
- Press **HOLD/SAVE** button.  
(Accumulated SMDR records will be printed out through the printer connected to KSU.)

Aria-300 : 01~99  
Aria-130 : 01~23  
Aria-186 : 01~99  
100 : 01~24  
34e :01~24



*Or using display, (Only in KD-33LD, KD/E-36LD, LKD-30LD)*



- Press the 4th menu key from the main menu to select FEATURE.
- Press **PAGE** down(▼) key 4 times.
- Select ACT GRP PRT SMDR key.
- Enter the account group to be printed.
- Press **HOLD/SAVE** button.



*In Aria-300/130, (Only in KD-33LD, KD/E-36LD, LKD-30LD)*



- Press the 5th menu key from the main menu to select PROGRAM.
- Select ATD PROGRAM key.
- Select GRP PRT SMDR key.
- Enter the account group to be printed.
- Press **HOLD/SAVE** button.

Attendant Operation



## To Erase SMDR Records

Button	Procedure
--------	-----------



- For station basis,* (Aria 16: Above V4.0  
20W : Above V3.0)
- Dial \* 2  
(Aria-300/130: **TRANS/PGM + 0 1 1 2**, Aria-16/20W: **TRANS/PGM \* 8 2**).
  - Enter the desired station range.  
(SMDR records will be erased for all stations in the range.)
  - Press **HOLD/SAVE** button.

*Or using display, (Only in KD-33LD, KD/E-36LD , LKD-30LD)*



- Press the 4th menu key from the main menu to select FEATURE.
- Press **PAGE** down(▼) key 4 times.
- Select STA DEL SMDR key.
- Enter the station range to be erased.
- Press **HOLD/SAVE** button.

*In Aria-300/130, (Only in KD-33LD, KD/E-36LD , LKD-30LD)*



- Press the 5th menu key from the main menu to select FEATURE.
- Select ATD PROGRAM key.
- Select STA DEL SMDR key.
- Enter the station range to be erased.
- Press **HOLD/SAVE** button.

*For call account group basis,*



- Dial \* 3 (Aria-300/130: **TRANS/PGM + 0 1 1 4**).
- Enter the desired account group.  
(SMDR records will be erased for all stations in the range.)
- Press **HOLD/SAVE** button.

*Or using display, (Only in KD-33LD, KD/E-36LD , LKD-30LD)*







- Press the 4th menu key from the main menu to select FEATURE.
- Press **PAGE** down(▼) key 4 times.
- Select ACT GRP DEL SMDR key.
- Enter the account group to be erased.
- Press **HOLD/SAVE** button.

*In Aria-300/130, (Only in KD-33LD, KD/E-36LD , LKD-30LD)*





- Press the 5th menu key from the main menu to select FEATURE.
- Select ATD PROGRAM key.
- Select GRP DEL SMDR key.
- Enter the station range to be erased.
- Press **HOLD/SAVE** button.

**To Erase SMDR Records (Cont'd)**

Button	Procedure
 HOLD/SAVE	<p><i>To display call charge,</i></p> <ul style="list-style-type: none"> <li>• Dial * 4 (<i>Aria-300/130: TRANS/PGM + 0 1 1 5</i>).</li> <li>• Enter the station number.</li> <li>• Press <b>HOLD/SAVE</b> button.</li> </ul> <p><i>Or using display, (Only in KD-33LD, KD/E-36LD, LKD-30LD)</i></p>
  HOLD/SAVE	<ul style="list-style-type: none"> <li>• Press the 4th menu key from the main menu to select FEATURE.</li> <li>• Press <b>PAGE</b> down(▼) key 4 times.</li> <li>• Select DISP CALL CHARGE key.</li> <li>• Enter the desired station number.</li> <li>• Press <b>HOLD/SAVE</b> button.</li> </ul>
 HOLD/SAVE	<p><i>In Aria-300/130, (Only in KD-33LD, KD/E-36LD, LKD-30LD)</i></p> <ul style="list-style-type: none"> <li>• Press the 5th menu key from the main menu to select FEATURE.</li> <li>• Select ATD PROGRAM key.</li> <li>• Select DISP CALL CHRГ key.</li> <li>• Enter the desired station number.</li> <li>• Press <b>HOLD/SAVE</b> button.</li> </ul>

Attendant Operation

**Dial by Name (for ICM) ( \* )**

Button	Procedure												
 TRANS/PGM	<ul style="list-style-type: none"> <li>• Press <b>TRANS/PGM</b> button.</li> <li>• Dial # 8 (<i>Aria-300/130: 0 7 2</i>).</li> <li>• Dial the station number and enter the name using the code shown below.</li> </ul> <table border="1" style="margin: 10px auto;"> <tr> <td>Q - 11 Z - 12 . - 13 1 - 10</td> <td>A - 21 B - 22 C - 23 2 - 20</td> <td>D - 31 E - 32 F - 33 3 - 30</td> </tr> <tr> <td>G - 41 H - 42 I - 43 4 - 40</td> <td>J - 51 K - 52 L - 53 5 - 50</td> <td>M - 61 N - 62 O - 63 6 - 60</td> </tr> <tr> <td>P - 71 R - 72 S - 73 Q - 7* 7 - 70</td> <td>T - 81 U - 82 V - 83 8 - 80</td> <td>W - 91 X - 92 Y - 93 Z - 9# 9 - 90</td> </tr> <tr> <td>*1 - Blank *2 - : *3 - ,</td> <td>0-00</td> <td>#</td> </tr> </table>	Q - 11 Z - 12 . - 13 1 - 10	A - 21 B - 22 C - 23 2 - 20	D - 31 E - 32 F - 33 3 - 30	G - 41 H - 42 I - 43 4 - 40	J - 51 K - 52 L - 53 5 - 50	M - 61 N - 62 O - 63 6 - 60	P - 71 R - 72 S - 73 Q - 7* 7 - 70	T - 81 U - 82 V - 83 8 - 80	W - 91 X - 92 Y - 93 Z - 9# 9 - 90	*1 - Blank *2 - : *3 - ,	0-00	#
Q - 11 Z - 12 . - 13 1 - 10	A - 21 B - 22 C - 23 2 - 20	D - 31 E - 32 F - 33 3 - 30											
G - 41 H - 42 I - 43 4 - 40	J - 51 K - 52 L - 53 5 - 50	M - 61 N - 62 O - 63 6 - 60											
P - 71 R - 72 S - 73 Q - 7* 7 - 70	T - 81 U - 82 V - 83 8 - 80	W - 91 X - 92 Y - 93 Z - 9# 9 - 90											
*1 - Blank *2 - : *3 - ,	0-00	#											
 HOLD/SAVE	<ul style="list-style-type: none"> <li>• Press <b>HOLD/SAVE</b> button.</li> </ul>												

**Dial by Name (for ICM) ( \* ) (Cont'd)**

Button	Procedure
--------	-----------

Or using display, (Only in KD-33LD, KD/E-36LD, LKD-30LD)



- Press the 5th menu key from the main menu to select PROGRAM.
- Select the ATD PROGRAM key.
- Press **PAGE** down(▼) key 3 times. On the display, you'll see the following.

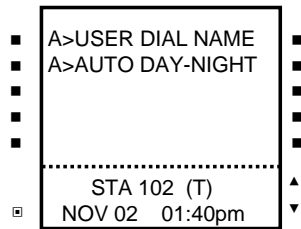

- Dial the station number and enter the name using the code.
- Press **HOLD/SAVE** button.

In Aria-300/130, (Only in KD-33LD, KD/E-36LD, LKD-30LD)



- Press the 5th menu key from the main menu to select PROGRAM.
- Select the ATD PROGRAM key.
- Press **PAGE** down(▼) key 6 times. On the display, you'll see the following.

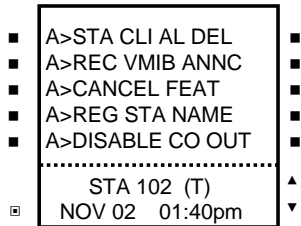

- Select the REG STA NAME key.
- Dial the station number and enter the name using the code.
- Press **HOLD/SAVE** button.

**Customized Message ( \* )**

Button	Procedure
--------	-----------



- Press **TRANS/PGM** button.
- Dial \* 7 (Aria-300/130: **0 5 3**).
- Dial the number of the desired message (11~20).
- Enter the desired message using the code in Dial by Name.
- Press **HOLD/SAVE** button.



## CO Outgoing Disable ( \* )





Button	Procedure
	<p><i>To disable outgoing calls a CO line,</i></p> <ul style="list-style-type: none"> <li>• Press <b>TRANS/PGM</b> button.</li> <li>• Dial * <b>8</b> (<i>Aria-300/130: 0 7 3</i>).</li> <li>• Press the desired outside line button. (Confirmation tone is heard.)</li> <li>• After hearing confirmation tone, selected outside line button is disabled.</li> <li>• Repeat the process to enable the CO line.</li> </ul>

Or using display, (*Only in KD-33LD, KD/E-36LD, LKD-30LD*)

	<ul style="list-style-type: none"> <li>• Press the 5th menu key from the main menu to select PROGRAM.</li> <li>• Select the ATD PROGRAM key.</li> <li>• Press <b>PAGE</b> down(▼) key once. On the display, you'll see the following. (In Aria-300/130, press <b>PAGE</b> down(▼) key 6 times.)</li> </ul> <div style="display: flex; justify-content: space-around; margin: 10px 0;"> <div style="border: 1px solid black; padding: 5px; width: 45%;"> <ul style="list-style-type: none"> <li>▪ A&gt;DISABLE CO OUT</li> <li>▪ A&gt;STA MSG ERASE</li> <li>▪ A&gt;SET ICMBX MSC</li> <li>▪ A&gt;CLOCK SET</li> <li>▪ A&gt;INTERCOM ONLY</li> <li>-----</li> <li style="text-align: center;">STA 102 (T)</li> <li style="text-align: center;">NOV 02 01:40pm</li> </ul> </div> <div style="border: 1px solid black; padding: 5px; width: 45%;"> <ul style="list-style-type: none"> <li>▪ A&gt;STA CLI AL DEL</li> <li>▪ A&gt;REC VMIB ANNC</li> <li>▪ A&gt;CANCEL FEAT</li> <li>▪ A&gt;REG STA NAME</li> <li>▪ A&gt;DISABLE CO OUT</li> <li>-----</li> <li style="text-align: center;">STA 102 (T)</li> <li style="text-align: center;">NOV 02 01:40pm</li> </ul> </div> </div> <p style="text-align: center; margin: 5px 0;">&lt;Aria-300/130&gt;</p> <ul style="list-style-type: none"> <li>• Select the DISABLE CO OUT key.</li> <li>• Press the desired outside line button. (Confirmation tone is heard.)</li> </ul>
---	---

## Temporary COS Change ( \* )



A station user can change the class of service to lower class temporarily to prevent unauthorized use of the station by others.

Button	Procedures
	<p><i>To activate temporary COS change,</i></p> <ul style="list-style-type: none"> <li>• Press <b>TRANS/PGM</b> button.</li> <li>• Dial # <b>2</b> (<i>Aria-300/130: 0 2 1</i>).</li> <li>• Enter the station range.</li> <li>• Press <b>HOLD/SAVE</b> button.</li> </ul>
	
	<p><i>To remove temporary COS change,</i></p> <ul style="list-style-type: none"> <li>• Press <b>TRANS/PGM</b> button.</li> <li>• Dial # <b>3</b> (<i>Aria-300/130: 0 2 2</i>).</li> <li>• Enter the station range.</li> <li>• Press <b>HOLD/SAVE</b> button.</li> </ul>
	

**Traffic Analysis ( \* )**



The system will monitor the system and record various traffic data which can be printed upon request. The information can be used to determine whether the circuits installed in the system are adequate.

When enabled, it will continue to monitor the traffic until disabled. The traffic data is collected and sent to the RS232C port upon request. The collected traffic data contains two types of traffic data. The first type is peg counts which give an actual count of the number of times a particular operation has occurred. Peg counts are given in absolute values from 00000 to 99999. The second type of data is usage times which give the average percent occupancy of a device, i.e., stations, CO lines, DTMF receivers, etc. Usage times are given in seconds from 00000 to 99999. Counts and times are cumulative from the time the monitoring is activated, and are reset by initiating the start up procedure again.

Button	Procedure
 	<p><i>To start the traffic analysis at system attendant,</i></p> <ul style="list-style-type: none"> <li>• Press <b>TRANS/PGM</b> button.</li> <li>• Dial <b># 7 1</b>.</li> <li>• Press <b>HOLD/SAVE</b> button.</li> </ul> <p><i>To stop the traffic analysis at system attendant,</i></p> <ul style="list-style-type: none"> <li>• Press <b>TRANS/PGM</b> button.</li> <li>• Dial <b># 7 2</b>.</li> <li>• Press <b>HOLD/SAVE</b> button.</li> </ul> <p><i>To print the result of traffic analysis at system attendant,</i></p> <ul style="list-style-type: none"> <li>• Press <b>TRANS/PGM</b> button.</li> <li>• Dial <b># 7 3</b>.</li> <li>• Press <b>HOLD/SAVE</b> button.</li> </ul> <p><i>To abort printing at system attendant,</i></p> <ul style="list-style-type: none"> <li>• Press <b>TRANS/PGM</b> button.</li> <li>• Dial <b># 7 4</b>.</li> <li>• Press <b>HOLD/SAVE</b> button.</li> </ul>

**Traffic Analysis (Aria-300/130) (Cont'd)**



The system can monitor and print various system activate based on the attendant's request. The traffic-monitoring program is activated only when enabled and will continue accumulating statistics until disabled. The traffic data is output to the RS-232C port upon manual request. The system will support the following traffic reports; Attendant Traffic Report, Call Summary Report, Call Hourly Report, H/W Unit Usage Summary Report, CO Traffic Report and CO Traffic Hourly Report.

Button	Procedure
	<p><i>To print all summary at system attendant,</i></p>
	<ul style="list-style-type: none"> <li>• Press <b>TRANS/PGM</b> button.</li> <li>• Dial <b>0 1 2 1</b>.</li> <li>• Select Measurement Time type.</li> <li>• Press <b>HOLD/SAVE</b> button.</li> </ul>
	<p><i>To print all summary traffic report periodically at system attendant,</i></p>
	<ul style="list-style-type: none"> <li>• Press <b>TRANS/PGM</b> button.</li> <li>• Dial <b>0 1 2 2</b>.</li> <li>• Press <b>HOLD/SAVE</b> button.</li> </ul>
	<p><i>To cancel periodic printing of all summary traffic reports,</i></p>
	<ul style="list-style-type: none"> <li>• Press <b>TRANS/PGM</b> button.</li> <li>• Dial <b>0 1 2 3</b>.</li> <li>• Press <b>HOLD/SAVE</b> button.</li> </ul>
	<p><i>To print the traffic report,</i></p>
	<ul style="list-style-type: none"> <li>• Press <b>TRANS/PGM</b> button.</li> <li>• Dial <b>0 1 2 4</b> (Attendant Traffic Report)</li> <li style="padding-left: 20px;"><b>0 1 2 5</b> (Call Summary Report)</li> <li style="padding-left: 20px;"><b>0 1 2 6</b> (Call Hourly Report)</li> <li style="padding-left: 20px;"><b>0 1 2 7</b> (H/W Unit Usage Summary Report)</li> <li style="padding-left: 20px;"><b>0 1 2 8</b> (CO Traffic Report)</li> <li style="padding-left: 20px;"><b>0 1 2 9</b> (CO Traffic Hourly Report)</li> <li>• Press <b>HOLD/SAVE</b> button.</li> </ul>

Attendant Operation

**Erasing Station Message ( \* )**

The attendant can cancel the features, DND CALL FORWARD and preselected message activating at other station.

Button	Procedure
	<ul style="list-style-type: none"> <li>• Press <b>TRANS/PGM</b> button.</li> <li>• Dial <b>* 9</b> (Aria-300/130: <b>0 7 1</b>).</li> <li>• Dial the desired station range to be canceled.</li> <li>• Press <b>HOLD/SAVE</b> button.</li> </ul>
	

## Attendant LCD Language

Button Procedure



*To change the LCD language at attendant,*

- Press **TRANS/PGM** button.
- Dial **5 1** (*Aria-300/130: 0 7 \**).
- Dial the station range to be changed.
- Select the language type with the following codes.  
(Aria-16/20W: English / Each Nation's Language)
- Press **HOLD/SAVE** button.

Type (00~25)

Aria-300/130:Type (00~14)

Aria-186	Aria-34e/100	Language	Aria-300/130	Language
0 0	0 0	English	0 0	English
0 1	0 1	Korean	0 1	Italian
0 2	0 2	Italian	0 2	Finnish
0 3	0 3	English for Large LCD	0 3	Dutch
0 4	0 4	Swedish	0 4	Swedish
0 5	0 5	Norwegian	0 5	Danish
0 6	0 6	Finnish	0 6	Norwegian
0 7	0 7	Dutch	0 7	Hungarian
0 8	0 8	Spanish	0 8	Germany
0 9	0 9	Korean for Large LCD	0 9	French
1 0	1 0	Danish	1 0	Portuguese
..	1 1	German	1 1	Spanish
..	1 2	German for Large LCD	1 2	Korean
1 3	1 3	Estonia	1 3	Estonia
1 2	1 4	Estonia for Large LCD	1 4	Russian
1 4	1 5	Swedish for Large LCD		
1 5	1 6	Italy for Large LCD		
1 6	1 7	Norway for Large LCD		
1 7	1 8	Finnish for Large LCD		
1 8	1 9	Dutch for Large LCD		
2 0	2 0	Russian		
9	2 1	Spanish for Large LCD		
2 1	2 2	Russian for Large LCD		
1 1	2 3	Danish for Large LCD		
2 2	2 4	Portuguese		
..	2 5	Portuguese for Large LCD		

*In Aria 16 / 20W (16: 4.0XX & 20W: 3.0XX)*





*To change the LCD language at attendant,*

- Press **TRANS/PGM** button.
- Dial **5 1**
- Dial the station range to be changed.
- Select the language ( English / Each Nation's Language)
- Press **HOLD/SAVE** button.

## Intercom Box BGM Selection by Attendant ( \* )

The attendant can select the music channel source to an ICM box.

Button	Procedure
  	<p><i>To set ICM box music,</i></p> <ul style="list-style-type: none"> <li>• Press <b>TRANS/PGM</b> button.</li> <li>• Dial * <b>0</b> (<i>Aria-300/130: 0 7 5</i>).</li> <li>• Dial the music channel (<i>0~9, Aria-300: 01~12, Aria-130:01~11</i>).</li> <li>• Press <b>HOLD/SAVE</b> button.</li> </ul>

Attendant Operation

*Or using display, (Only in KD-33LD, KD/E-36LD, LKD-30LD)*



	<ul style="list-style-type: none"> <li>• Press the 5th menu key from the main menu to select PROGRAM.</li> <li>• Select the ATD PROGRAM key. On the display, you will see the following.</li> </ul> <div style="border: 1px solid black; padding: 5px; margin: 10px 0;"> <pre> A&gt;WAKE-UP SET A&gt;WAKE-UP ERASE A&gt;PASSWORD ERASE A&gt;CHG DATE MODE A&gt;CHG TIME MODE ----- STA 102 (T) NOV 02 01:40pm                     </pre> </div> <ul style="list-style-type: none"> <li>• Press <b>PAGE</b> down(▼) key once. You'll see the following.</li> </ul> <div style="border: 1px solid black; padding: 5px; margin: 10px 0;"> <pre> A&gt;DISABLE CO OUT A&gt;STA MSG ERASE A&gt;SET ICMBOX MSC A&gt;CLOCK SET A&gt;INTERCOM ONLY ----- STA 102 (T) NOV 02 01:40pm                     </pre> </div> <ul style="list-style-type: none"> <li>• Select the SET ICMBOX MSC.</li> <li>• Press the Music type;                         <ul style="list-style-type: none"> <li>0 : No music</li> <li>1~9 : Music from channel 1~9</li> </ul> </li> <li>• Press <b>HOLD/SAVE</b> button.</li> </ul>
---	--

*In Aria-300/130, (Only in KD-33LD, KD/E-36LD, LKD-30LD)*

	<ul style="list-style-type: none"> <li>• Press the 5th menu key from the main menu to select PROGRAM.</li> <li>• Select the ATD PROGRAM key. On the display, you will see the following.</li> </ul> <div style="border: 1px solid black; padding: 5px; margin: 10px 0;"> <pre> A&gt;STA PRT SMDR A&gt;STA DEL SMDR A&gt;GRP PRT SMDR A&gt;GRP DEL SMDR A&gt;DISP CALL CHR ----- STA 102 (T) NOV 02 01:40pm                     </pre> </div>
--	--





**Intercom Box BGM Selection by Attendant ( \* ) (Cont'd)**

Button	Procedure
	<ul style="list-style-type: none"> <li>Press <b>PAGE</b> down(▼) key 7 times. You'll see the following.</li> </ul>
	<div data-bbox="427 443 671 667" style="border: 1px solid black; padding: 5px; margin-bottom: 10px;"> <ul style="list-style-type: none"> <li>■ A&gt;AUTO D/N/W ■</li> <li>■ A&gt;ICMBX BGM SEL ■</li> <li>■ A&gt;BGM TO EXT 1 ■</li> <li>■ A&gt;BGM TO EXT 2 ■</li> <li>■ A&gt;BGM TO EXT 3 ■</li> <li>.....</li> <li>STA 102 (T) ▲</li> <li>NOV 02 01:40pm ▼</li> </ul> </div> <ul style="list-style-type: none"> <li>Select the ICMBX MSC SEL.</li> <li>Press the Music type;                             <ul style="list-style-type: none"> <li>00 : No music</li> <li>Aria-300: 01~12 ( Music from channel 1~12 )</li> <li>Aria-130: 01~11 ( Music from channel 1~11 )</li> </ul> </li> <li>Press <b>HOLD/SAVE</b> button.</li> </ul>

**External Page Port BGM Selection by Attendant (Only in Aria-300/130)**

Button	Procedure
	<p><i>To set External Page Port music,</i></p> <ul style="list-style-type: none"> <li>Press <b>TRANS/PGM</b> button.</li> <li>Dial <b>0 7 6</b> (External Port 1), <b>0 7 7</b> (External Port 2), or <b>0 7 8</b> (External Port 3).</li> <li>Dial the music channel (Aria-300: 01~12, Aria-130 : 01~11).</li> <li>Press <b>HOLD/SAVE</b> button.</li> </ul>

*In Aria-300/130, (Only in KD-33LD, KD/E-36LD, LKD-30LD)*

	<ul style="list-style-type: none"> <li>Press the 5th menu key from the main menu to select PROGRAM.</li> <li>Select the ATD PROGRAM key and press <b>PAGE</b> down(▼) key 7 times. Then you will see the following.</li> </ul>
	<div data-bbox="427 1496 671 1720" style="border: 1px solid black; padding: 5px; margin-bottom: 10px;"> <ul style="list-style-type: none"> <li>■ A&gt;AUTO D/N/W ■</li> <li>■ A&gt;ICMBX BGM SEL ■</li> <li>■ A&gt;BGM TO EXT 1 ■</li> <li>■ A&gt;BGM TO EXT 2 ■</li> <li>■ A&gt;BGM TO EXT 3 ■</li> <li>.....</li> <li>STA 102 (T) ▲</li> <li>NOV 02 01:40pm ▼</li> </ul> </div> <ul style="list-style-type: none"> <li>Select the BGM TO EXT 1~3.</li> <li>Press the Music type;                             <ul style="list-style-type: none"> <li>00 : No music</li> <li>Aria-300 : 01~12 ( Music from channel 1~12)</li> <li>Aria-130 : 01~11 ( Music from channel 1~11)</li> </ul> </li> <li>Press <b>HOLD/SAVE</b> button.</li> </ul>

**Attendant DSS Operation /Placing an Intercom Call from the DSS**

Button	Procedures
	<ul style="list-style-type: none"> <li>• Lift handset or press <b>MON</b> button.</li> <li>• Press the desired DSS station button.</li> <li>• Hang up or press <b>RELEASE</b> button to terminate the call. (<b>RELEASE</b> button is not available in Aria-300/130, Aria-16/20W.)</li> </ul>

**Making a Page**

Button	Procedure
	<ul style="list-style-type: none"> <li>• Lift handset or press <b>MON</b> button.</li> <li>• Press <b>PAGE</b> button.</li> <li>• Speak in normal voice tone to announce message.</li> <li>• Hang up or press <b>RELEASE</b> button. (<b>RELEASE</b> button is not available in Aria-300/130, Aria-16/20W.)</li> </ul>

**Transferring an Outside Line to Another Station**

Button	Procedure
	<ul style="list-style-type: none"> <li>• While connecting an outside line, press the desired DSS station button.</li> <li>• You can wait to announce the transfer or,</li> <li>• Hang up or press <b>RELEASE</b> button. (<b>RELEASE</b> button is not available in Aria-300/130, Aria-16/20W.)</li> </ul>

**Intercom Group Call ( \* )**

Button	Procedure
	<ul style="list-style-type: none"> <li>• Lift handset or press <b>MON</b> button.</li> <li>• Press the programmed INTERCOM GROUP CALL button.</li> <li>• The call is connected to an idle station in the group.</li> </ul>

**Overriding a Key Telephone in Do Not Disturb**

Button	Procedure
	<ul style="list-style-type: none"> <li>• Press DSS button of the station to be overridden. (DND tone or busy tone is heard.)</li> <li>• Press programmed OVERRIDE button.</li> </ul>

*In Aria-300/130, Aria-16/20W*

	<ul style="list-style-type: none"> <li>• Press DSS button of the station to be overridden. (DND tone or busy tone is heard.)</li> <li>• Dial * to override the station in DND or in busy.</li> </ul>
--	--

### Attendant Programming Menu Table

The attendant can program some features with this table by pressing **TRANS/PGM** button and appropriate codes.

Attendant Main Menu	Attendant Sub Menu - I	Attendant Sub Menu - II	Selection	Remark		
[1]PRINT	[1] SMDR	[1] PRINT SMDR (STA BASE)	STN# (+ END STN#)	MAIN ATD		
		[2] DELETE (STA BASE)	STN# (+ END STN#)	MAIN ATD		
		[3] PRINT SMDR (GRP BASE)	GRP# (+ END GRP#)	MAIN ATD		
		[4] DELETE (GRP BASE)	GRP# (+ END GRP#)	MAIN ATD		
		[5] DISPLAY CALL CHARGE		MAIN ATD		
		[6] ABORT PRINTING	None	MAIN ATD		
		[7] PRINT LOST CALL		MAIN ATD		
		[8] DELETE LOST CALL		MAIN ATD		
	[2] TRAFFIC	[1] PRINT ALL SUMMARY	Analysis Time Type	MAIN ATD		
		[2] PRINT ALL PERIODIC	Analysis Time Type , Print Time (Hour)	MAIN ATD		
		[3] ABORT PERIODIC PRINT	None	MAIN ATD		
		[4] PRINT ATD TRAFFIC	Analysis Time Type	MAIN ATD		
		[5] PRINT CALL SUMMARY	None	MAIN ATD		
		[6] PRINT CALL HOURLY	None	MAIN ATD		
		[7] PRINT H/W USAGE	Analysis Time Type	MAIN ATD		
		[8] PRINT CO SUMMARY	Analysis Time Type	MAIN ATD		
		[9] PRINT CO HOURLY	Enter CO Grp #	MAIN ATD		
		[2]COS	[1] SET ICM ONLY MODE		STN# (+ END STN#)	
			[2] RESTORE COS		STN# (+ END STN#)	
[3]AUTHORIZATION	[1] CHANGE AUTHORIZATION		STN# (+ END STN#)	MAIN or GROUP ATD		
[4]TIME	[1] CHANGE DATE/TIME		MM/DD/YY	MAIN ATD		
	[2] SET WAKE UP		STN# (+ END STN#)	MAIN or GROUP ATD		
	[3] DISABLE WAKE UP		STN# (+ END STN#)	MAIN or GROUP ATD		
	[4] LCD DATE MODE		MMDDYY/DDMMYY	MAIN ATD		
	[5] LCD TIME MODE		12H/24H	MAIN ATD		
	[6] USE PX TIME /DATE		ON/OFF	MAIN ATD		

**Attendant Programming Menu Table (Cont'd)**

Attendant Main MENU	Attendant Sub Menu - I	Attendant Sub Menu - II	Selection	Remark
[5] MESSAGE	[1] PRESELECT MSG ACT		STN# (+ END STN#) + MSG #(00-10)	MAIN or GROUP ATD
	[2] PRESELECT MSG DEACT		STN# (+ END STN#)	MAIN or GROUP ATD
	[3] CUSTOM MSG REG		MSG # (11-20) + MSG STREAM	MAIN or GROUP ATD
	[4] ERASE VM MSG		STN# (+ END STN#)	
	[5] ATD DEL ALL CLI MSG			
[6] REC. VMIB ANNOUNCEMENT			VMIB ANNC# (01-70)	SYSTEM ATD
[7] SUPPLEMENTARY	[1] CANCEL FEATURES		STN# (+ END STN#)	MAIN or GROUP ATD
	[2] REGISTER STA NAME		STN# + NAME	MAIN ATD
	[3] DISABLE CO OUTGOING		PRESSING CO BTN	MAIN ATD
	[4] AUTO RING MODE		ATD/AUTO	
	[5] ICM BOX BGM CH SEL		BGM CHANNEL # (01-12)	MAIN ATD
	[6] EXT PORT#1 BGM EN/DI		ENABLE / DISABLE	MAIN ATD
	[7] EXT PORT#2 BGM EN/DI		ENABLE / DISABLE	MAIN ATD
	[8] EXT PORT#3 BGM EN/DI		ENABLE / DISABLE	MAIN ATD
	[9] PREPAID CALL			
	[*] LCD DISPLAY LANGUAGE			
[*] BOARD SERVICE SWITCH			SLOT NUMBER (01 – 27)	
[#] WHTU SUBSCRIBE			FLEX 1 – FLEX 9	

Attendant Operation

**Index**

<b>A</b>		<b>U</b>	
Access Authorization Code.....	30	Universal Night Answer .....	16
Alarm Reset .....	48	User Custom Message Programming .....	39
Answering a Call Wait with Voice Over .....	20	Using Dial By Name .....	34
Answering an Intercom Call .....	18	<b>V</b>	
Answering an Outside Call .....	11	Voice Announcement .....	40
Auto Call Number Redial .....	13	Voice Over .....	20
<b>B</b>		<b>W</b>	
Background Music .....	40	Wake-up Call .....	33
Blocking Outside Calls .....	32	<b>Large LCD Keypad Features</b>	
<b>C</b>		Calendar Display .....	49
Call Back .....	21	Door Open .....	50
Call Forward .....	23	LCD Brightness Control .....	49
Call Park .....	16	<b>Attendant Operation</b>	
Call Transfer .....	11	Attendant Clock Set.....	57
Call Wait .....	21	Attendant DSS Operation .....	73
Changing Differential Ring .....	19	Attendant Intrusion .....	60
Changing Intercom Answer Mode .....	17	Attendant LCD Language .....	70
CO Message Wait .....	47	Attendant Programming Menu Table .....	74
Conference .....	29	Changing Time/Date.....	57
<b>D</b>		CO Outgoing Disable .....	67
Dial Memo .....	13	Customized Message .....	66
Directed Call Pick-up .....	20	Day/On-demand/Night Mode Service .....	61
DISA (Direct Inward System Access) .....	47	Dial By Name .....	65
Do Not Disturb .....	22	Erasing Station Message .....	69
<b>E</b>		External Page Port BGM Selection by ATD .....	72
Executive/Secretary Transfer .....	14	Intercom Box BGM Selection by Attendant .....	71
<b>F</b>		Overriding a Key Telephone in DND .....	73
Flash .....	26	System Greetings .....	56
<b>G</b>		System Speed Dial .....	60
Group Call Pick-up .....	28	Temporary COS Change .....	67
<b>L</b>		To Erase SMDR Record .....	64
Last Number Redial .....	12	To Print out Accumulated SMDR Records .....	62
LCD Language Change .....	47	To Set Current Time 1 Hour Early/Late .....	59
<b>M</b>		Traffic Analysis .....	68
Message Waiting .....	22	Wake-up Call .....	54
Mute .....	21	<b>Hotel Operation(Aria/Aria)</b>	
<b>P</b>		Authorization Code.....	79,90
Paging .....	25	Auto Internal Speed Directory .....	85,96
Placing a CO Call on Hold .....	28	Baby Listening .....	80,91
Placing an Intercom Call .....	18	Bath Alarm .....	83,94
Placing an Intercom Group Call .....	28	Brief SMDR Print .....	86,97
Placing an Intercom on Hold .....	18	Call Charge Rate .....	80,91
Placing an Outside Call .....	11	Change LCD Display Language .....	82,93
Pre-selected Message .....	37	Check-In .....	76,87
Programming Your Name into Display .....	37	Check-In/Change a Guest Room Status .....	77,88
<b>Q</b>		Check-Out .....	80,91
Queuing .....	13	Class Of Service .....	78,89
<b>R</b>		Fee for Part Time .....	85,96
Ring Volume Control .....	27	Guest Alarm Call .....	78,89
Restoring Outside Calls .....	32	Intercom Enable/Disable .....	78,89
<b>S</b>		Maid Status .....	83,94
Save Number Redial .....	12	Multiple Front Desk .....	86,97
Speakerphone .....	27	New Cabina Call .....	86,97
Speaker Volume Control .....	27	One-time CO Call Enable.....	82,93
Speed Dial Numbers .....	14	Pre-paid Call Charge .....	79,90
Station Programming Menu Table .....	51	Printing a Guest Room Status.....	81,92
Step Call .....	14	Register Bar & Mini-Bar Charge .....	84,95
Storing Dial By Name .....	15	Register & Change a Guest Name .....	77,88
<b>T</b>		Register Hotel Name. ....	76,87
Two-way Recording .....	49	Room Charge Display & Printing .....	81,92
Time and date. ....	57	Room Rate Assign .....	84,95
		Room to Room Call Group .....	84,95